

robosense® **LiDAR**

Ruby Plus

RUBY PLUS

User Guide

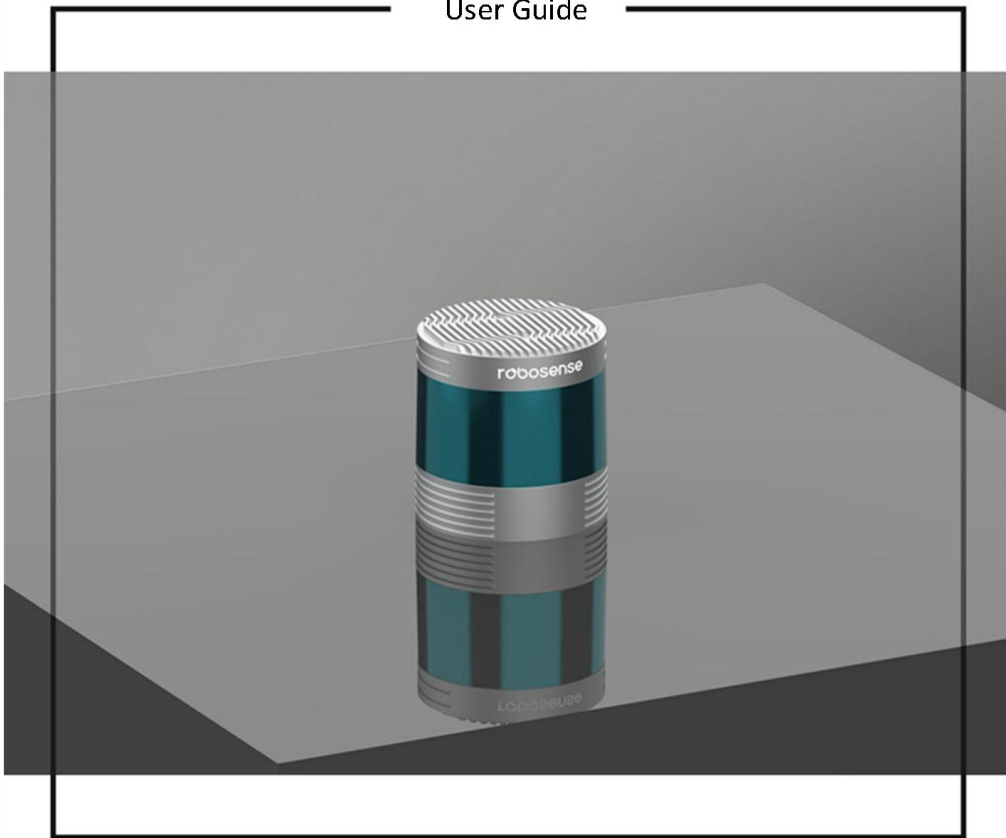



Version 1.0

Change Description

Version	Revision Date	Description
1.0	2023/8/19	Initial release
1.1	2023/11/6	<ol style="list-style-type: none">1. Increase LiDAR weight tolerance range2. Update LiDAR coordinate illustration3. Update the MSOP package description and the distance resolution value;4. Updated the Angle pulse parameter description
1.2	2024/7/16	<ol style="list-style-type: none">1. Update LiDAR weight2. Update Time Synchronization Register Description

Reading Prompt

Symbolic Instructions

-  Warning: The usage process should be strictly followed, otherwise it may lead to potential dangerous situations such as minor injuries or property damage.
-  Important: The usage process should be observed, otherwise it may cause potential harmful situations such as product damage.
-  Tip: The usage process should be valued sufficiently to achieve maximum value of the product efficiently and smoothly.

Resource Download

Please click the following link to download the latest product manual, RSview and other resources: <https://www.robosense.cn/resources>

More Information

Manufacturer: Suteng Innovation Technology Co., Ltd. (RoboSense).

Website: <https://www.robosense.cn/>

Technical Support: support@robosense.cn

Address: Building 9, Block 2, Zhongguan Honghualing Industry Southern District, 1213 Liuxian Avenue, Taoyuan Street, Nanshan District, Shenzhen, China

Phone: 0755-86325830

Email: service@robosense.cn (new email address)

Working Hours: Monday to Friday, 9:00 AM to 6:00 PM (GMT/UTC +8)

Content

Change Description	1
Reading Prompt	2
Content	3
1 Safety Notices	6
1.1 Legal Statement	6
1.2 User Guidelines	6
1.3 Illegal Operation	6
1.4 Requirements for Operating Personnel	7
1.5 Work Safety and Special Hazards	7
2 Product Description	9
2.1 Product Overview	9
2.2 Product Structure	9
2.3 FOV Distribution	10
2.4 Specifications	11
2.5 Product Principle	12
2.5.1 Coordinate Mapping	12
2.5.2 Reflectivity Interpretation	12
2.5.3 Return Modes	12
2.5.4 Phase Locking	13
2.5.5 Time Synchronization Mode	14
3 Product Installation	18
3.1 Accessory Description	18
3.2 Mechanical Installation	18
3.3 Interface Description	20
3.3.1 Aviation Plug Interface and Definitions	20
3.3.2 Interface Box	22
3.3.3 Power Interface	23
3.3.4 I/O Interface	23
3.3.5 RJ45 Ethernet Port	23
3.4 Quick Connection	23
4 Product Usage	27
4.1 Product Coordinate System	27
4.2 Web UI Usage	27
4.2.1 Web UI Functions	27

4.2.2	Accessing the Web UI Interface	27
4.2.3	Using the Web UI Interface	28
4.3	RSView Usage	28
4.3.1	Software Functions	28
4.3.2	Installing RSView	29
4.3.3	Using RSView	29
4.4	Communication Protocols	29
4.4.1	MSOP and DIFOP Data Protocols	29
4.4.2	Main Data Stream Output Protocol (MSOP)	30
4.4.3	Device Info Output Protocol (DIFOP)	33
5	Product Maintenance	36
5.1	Transportation and Logistics	36
5.2	Storage	36
5.3	Product Cleaning	36
5.3.1	Precautions	37
5.3.2	Required Materials	37
5.3.3	Cleaning Method	37
6	Fault Diagnosis	38
7	After-sales Service	40
Appendix A	Web UI Operation	41
A.1	Product Information	41
A.2	Product Parameter Settings	42
A.3	Product Diagnostics / Operating Status	44
A.4	Product Firmware Upgrade	45
Appendix B	ROS & ROS2 Package	48
Appendix C	Register Definitions	49
C.1	Motor Speed (MOT_SPD) Register	49
C.2	Ethernet (ETH) Register	49
C.3	FOV Setting (FOV_SET) Register	50
C.4	Motor Phase (MOT_PHASE) Register	50
C.5	Main Board Firmware Version (TOP_FRM)	50
C.6	Bottom Board Firmware Version (BOT_FRM)	51
C.7	APP Software Version (SOF_FRM)	51
C.8	Motor Firmware Version (MOT_FRM)	51
C.9	Web CGI Version (CGI_FRM)	52
C.10	Serial Number (SN)	52
C.11	Time Synchronization Information (TIME_SYNC_INF)	52

C.12 Time (UTC_TIME)	53
C.13 Runtime Status (STATUS).....	53
C.14 Fault Diagnosis (FALT_DIGS)	53
C.15 GPRMC Data Packet - ASCII Code Data Type	54
C.16 Vertical Angle Calibration (COR_VERT_ANG).....	55
C.17 Horizontal Angle Calibration (COR_HOR_ANG).....	56
Appendix D Accurate Point Time Calculation	58
Appendix E Channel Ranging Capability Table	62
Appendix F Mechanical Drawings	64

1 Safety Notices

1.1 Legal Statement

 Unless otherwise stated, all rights (including copyrights, trademarks, patents, trade secrets, and other related rights) in RoboSense's products, technologies, software, programs, data, and other information (including text, icons, photographs, audio, video, graphics, color combinations, layout design, etc.) are owned by RoboSense and its licensors.

 No one may use any content contained in this manual in any unauthorized manner without the prior written consent of RoboSense.

 The word "RoboSense" and other logos and product and service names are owned by RoboSense. If you need to use them for any advertising or displaying purposes, you must obtain prior written authorization from RoboSense.

1.2 User Guidelines

 Please use this product in accordance with the following requirements:

- 1) Please strictly abide by relevant national laser safety laws and regulations;
- 2) Please read this product manual in detail before using the product;
- 3) Please use this product only in the relevant field of application;
- 4) Please avoid using this product in environments that are explosive, highly corrosive, or beyond the IP protection level of the equipment.

1.3 Illegal Operation

 Please use this product in accordance with the regulations, otherwise it may cause product damage, property loss, and personal injury. Users are responsible for risk arising from unauthorized operations.

- 1) Do not disassemble or modify this product (including accompanying accessories);

- 2) Non-specified power supply and accompanying accessories are prohibited;
- 3) Please avoid abnormal operations such as dropping, colliding, burning, etc.;
- 4) If you notice any damage to the appearance of the device (arc protection cover), please immediately stop using it;
- 5) If you notice any abnormal operation of the product, please immediately stop using it and contact RoboSense in a timely manner.

1.4 Requirements for Operating Personnel

! The use of this product requires certain basic professional knowledge and other related requirements for operating personnel. Unreasonable operations performed by personnel without basic knowledge or training do not constitute a fault of RoboSense and may cause damage to equipment and personal property.

- 1) Please read the product manual in detail before using the device;
- 2) Prohibit illegal operations;
- 3) Before working, personnel must undergo training and obtain relevant construction qualifications;
- 4) Have some basic knowledge of computer data connection, electrical, and so on.

1.5 Work Safety and Special Hazards

! To avoid risks of accidents, damage to sensor or violating of your product warranty, please read and follow the instructions in this manual carefully before operating the product.

- 1) Laser Safety: This product meets the following standards for laser products: IEC 60825-1:2014;:



- 2) High Temperature Warning: Please pay attention to the overheating sign on the LiDAR surface to avoid a hot LiDAR surface that may lead to sensor

failure or undesirable consequences.



- 3) Retain Instructions: The safety and operating instructions should be retained for future reference.
- 4) Heed Warnings: All warnings on the product and in the operating instructions should be adhered to.
- 5) Servicing: Except for what's described in this manual, the sensor has no field serviceable parts. For servicing, please contact RoboSense sales or the authorized distributors.

2 Product Description

2.1 Product Overview

Ruby Plus is a new flagship 128-line LiDAR by RoboSense, featuring a modular and innovative design for L4+ autonomous driving. It breaks through the measurement range to 240 meters at 10% reflectivity and offers a vertical angle resolution of 0.1° and a horizontal angle resolution of 0.1° (high-performance mode). It provides denser point cloud information in both vertical and horizontal directions, enabling long-distance detection of pedestrians and vehicles and significantly increasing response time for high-speed driving. Additionally, Ruby Plus exhibits enhanced ground and lane detection capabilities.

Compared to the previous generation product, Ruby Plus has reduced its volume by 52%, weight by 50%, and power consumption by 33%.

2.2 Product Structure

The structure of Ruby Plus is illustrated in Figure 1 .

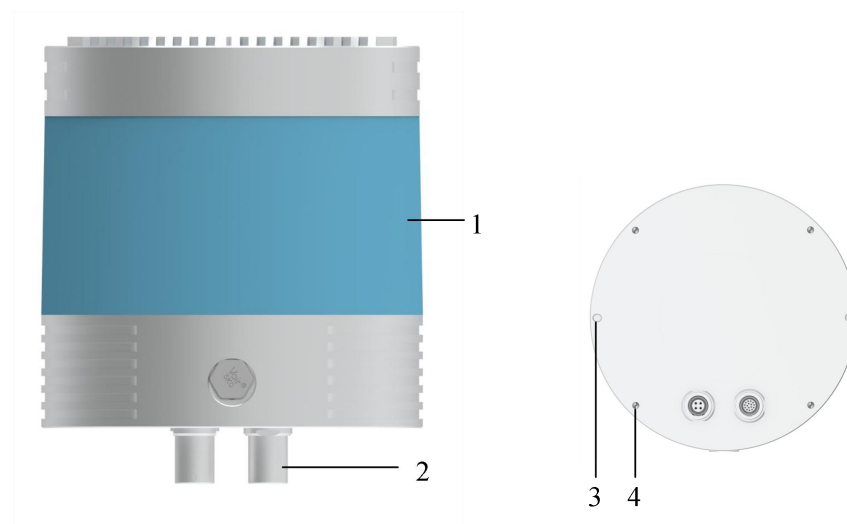

Figure 1 Product Structure Description

It mainly includes the following components:

- 1) Protective Cover

Both the emitted laser and returned laser need to pass through the specially designed

arc-shaped protective cover. Therefore, any obstruction within the laser's field of view (FOV) is strictly prohibited.

2) Aviation Connector

The LiDAR main body is connected to the interface box via aviation connectors, enabling power supply and data transmission. Ruby Plus has two aviation connectors on its base: a 4-core communication aviation connector and a 16-core power and I/O signal connection aviation connector.

3) Mounting Holes

Used to support and fix the position and orientation between the LiDAR and the bracket, it enhances installation efficiency and accuracy.

4) M4 Screw Mounting Holes

Used to secure the LiDAR to the mounting bracket with M4 screws.

2.3 FOV Distribution

Ruby Plus has a horizontal FOV range of 0° to 360° and a vertical FOV range of -25° to $+15^{\circ}$, with a minimum angle interval of 0.1° non-uniformly distributed. The 128 lasers are defined as 128 channels, and their correspondence with the actual vertical angles is shown in Figure 2 (b).

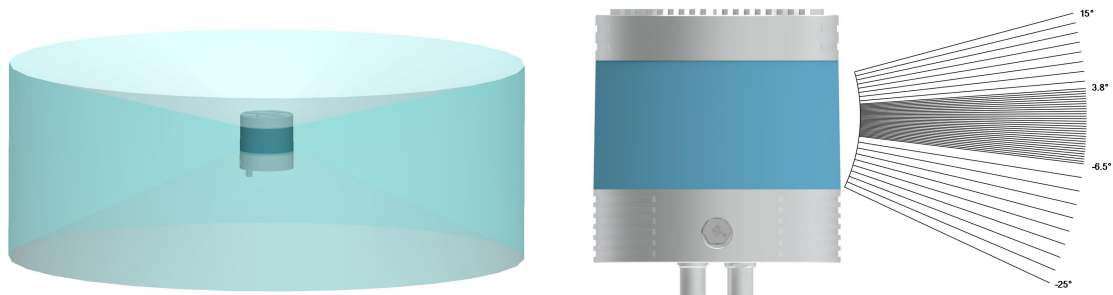

(a) FOV Area Distribution

(b) Vertical Angular Distribution

Figure 2 FOV Illustration

2.4 Specifications

Table 1 Ruby Plus Specifications

Specifications			
Number of Channels	128	Horizontal Field of View (FOV)	360°
Laser Wavelength	905 nm	Vertical Field of View (FOV)	-25° ~ +15° (Total 40°)
Laser Emission Angle (Full Angle)	Horizontal 1.0 mrad, Vertical 1.7 mrad	Horizontal Angular Resolution	0.2° / 0.4° (Balanced Mode) 0.1° / 0.2° (High-Performance Mode)
Laser Safety Level	Class I Eye-Safe	Vertical Angular Resolution	-6.5° ~ +3.81°: 0.1° (104 channels)
Measurement Range ¹	0.4 m to 250 m (240 m @ 10% NIST)	Accuracy (Typical) ²	2 cm (1σ) / 3 cm (3σ)
Blind Zone	0.4 m	Frame Rate	10 Hz / 20 Hz
Rotation Speed	600 / 1200 rpm (10 / 20 Hz)		
Number of Output Points	2,304,000 pts/s (Single Return Mode), 4,608,000 pts/s (Dual Return Mode)		
Ethernet Transmission Rate	1000 Mbps (1000Base-T1 protocol)		
Output Data Protocol	UDP Packets Over Ethernet		
Lidar Data Packet Content	3D spatial coordinates, reflectivity, timestamp, etc.		
Operating Voltage	9 V - 32 V	Dimensions	Diameter 125 mm x Height 128 mm
Product Power Consumption ³	27 W (Typical)	Operating Temperature ⁴	- 40°C ~ + 60°C
Weight	1920g ± 50g (LiDAR Body)	Storage Temperature	- 40°C ~ + 85°C
Time Synchronization	GPS, PTP & gPTP	Protection Level	IP67 / IP6K9K
Product Model	RP128		

 Note:

It is not recommended to use the high-performance mode and dual return mode

¹ Measurement Range is based on a 10% NIST diffuse reflection target, and the test results are subject to environmental factors such as ambient temperature and light intensity.;

² Measurement Accuracy is based on a 50% NIST diffuse reflection target, and the test results are affected by environmental factors, including ambient temperature and target distance. The accuracy value applies to most channels, but variations may exist between certain channels;

³ Device Power Consumption test results are influenced by external environmental factors, including ambient temperature, target distance, and target reflectivity;

⁴ Device Operating Temperature may be affected by external environmental factors, including lighting conditions and airflow variations;

simultaneously due to potential packet loss issues caused by large data volume.

2.5 Product Principle

2.5.1 Coordinate Mapping

As the LiDAR data packet contains only horizontal rotation angles and distance parameters, to present a three-dimensional point cloud, the polar coordinates (angle and distance) are transformed into Cartesian coordinates (x, y, z) according to the following equations:

$$\begin{cases} x = r \cos(\omega) \sin(\alpha) + R \cos(\alpha); \\ y = r \cos(\omega) \cos(\alpha) + R \sin(\alpha); \\ z = r \sin(\omega); \end{cases}$$

where r is the measured distance, ω is the laser's vertical angle, α is the laser's horizontal rotation angle, R is the plane radius from the optical center to the origin, and x, y, z are the coordinates projected onto the Cartesian X, Y, Z axes.

2.5.2 Reflectivity Interpretation

Ruby Plus LiDAR provides reflectivity information to characterize the reflectance of measured objects. In Ruby Plus data, the calibrated reflectivity range is from 1 to 255.

2.5.3 Return Modes

2.5.3.1 Return Modes Principle

Ruby Plus supports multiple return modes, including Strongest Return, Last Return, First Return, and Dual Return modes. In the Dual Return mode, detailed information of the target object is displayed, and the data volume is twice that of the Single Return mode.

Ruby Plus analyzes multiple return values received and outputs the strongest, last, or first return value based on user selection, or outputs dual return values. In the Strongest Return mode, only the strongest reflected return value is output; in the Last Return mode, only the last detected return in the time domain is output.

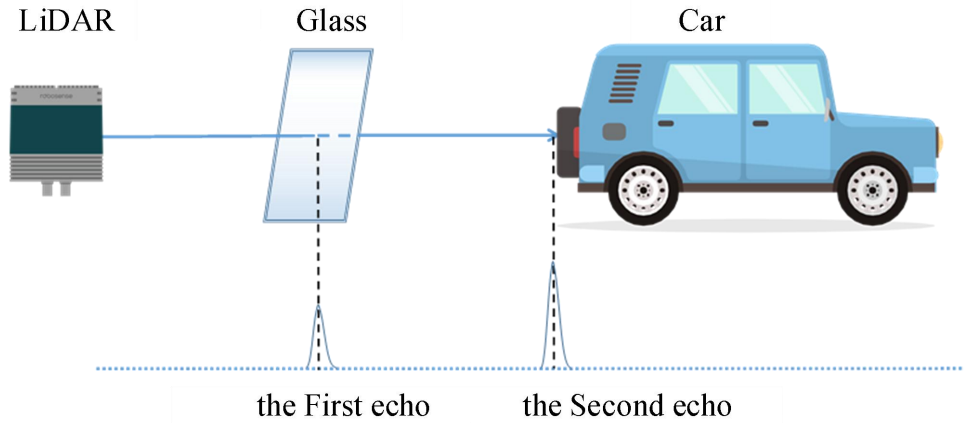

Figure 3 Dual Return Detection

i Note:

- 1) Dual Return Mode includes three types of return combinations: First & Strong (the first and strongest return), First & Last (the first and last return), and Strong & Last (the strongest and last return).
- 2) In Dual Return mode, when the laser hits multiple targets, and the distance between the targets is greater than 1 meter, the LiDAR can detect two echoes, as shown in Figure 3 .

2.5.3.2 Return Mode Flags

By default, Ruby Plus is set to the Strongest Return mode. If the user needs to change the settings, please refer to Appendix A.2 in the product parameter setting for configuration. In DIFOP, the 300th byte represents the flag for the return mode, as shown in Table 2:

Table 2 Return Mode and Flags Mapping

DIFOP Offset	Flag	Return Mode
300	00	Strongest Return
	01	Last Return
	02	First Return
	03	Strongest + Last Return
	04	Strongest + First Return
	05	Last + First Return

2.5.4 Phase Locking

Ruby Plus's phase locking function allows the device to emit lasers at specific angles when the sensor reaches a whole second. Figure 4 illustrates Ruby Plus's setup with different phase angles. The red arrows indicate that at the whole second, the sensor

rotates to 0° , 135° , and 270° to emit lasers. Refer to Figure 13 for the coordinate system details.

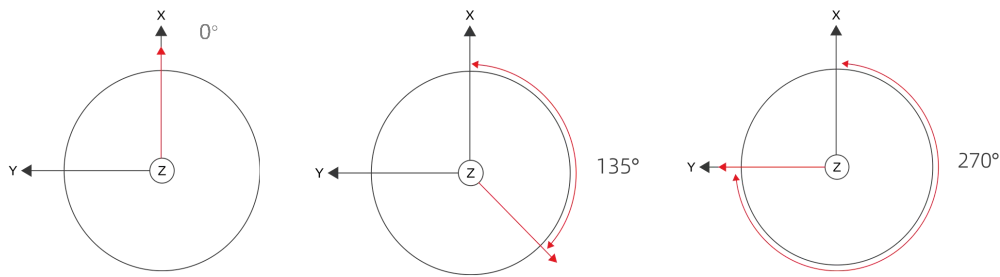

Figure 4 Ruby Plus Phase Lock Setting Illustration

The "Phase Lock" parameter setting is available in the Web interface under Setting > Phase Lock Setting. It allows users to set the locked phase angle, which should be an integer ranging from 0 to 359. For more details, refer to section 4.2 of the product manual.

2.5.5 Time Synchronization Mode

Ruby Plus supports three time synchronization methods: GPS + PPS, PTP (IEEE 1588 V2 protocol), and gPTP (IEEE 802.1 AS protocol). Users can configure these settings through the Web interface. For more details, refer to section 4.2 of the product manual.

2.5.5.1 GPS Time Synchronization Principle

The GPS module continuously sends GPRMC data and PPS synchronization pulse signals to the product. The PPS synchronization pulse length should be between 20 to 200 ms, and the GPRMC data must be completed within 500 ms of the synchronization pulse. The timing diagram is shown in Figure 5 .

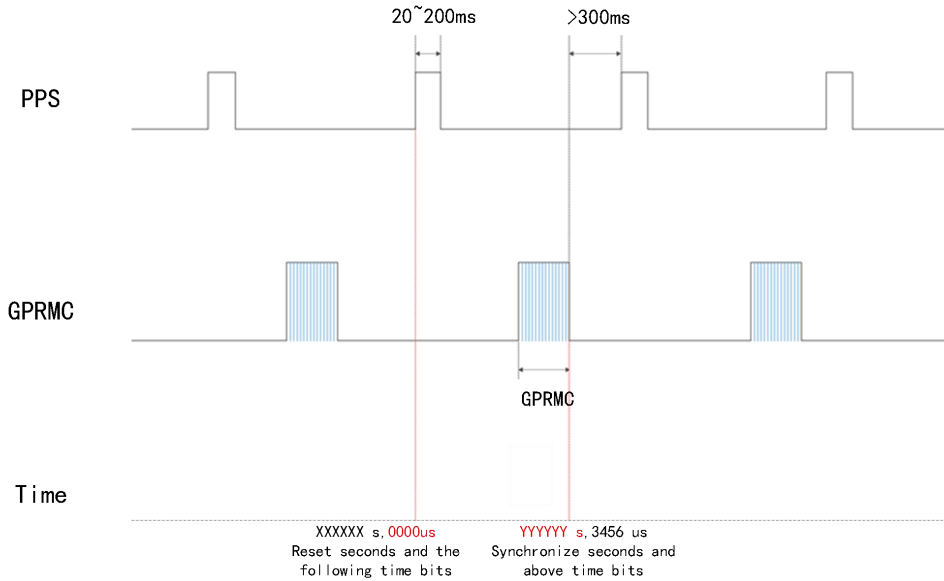

Figure 5 GPS Time Synchronization Timing Diagram

i Note:

To ensure accurate time synchronization, it is recommended to set the PPS pulse width between 20 to 200 ms. The completion time of GPRMC is recommended to be within 500 ms after the rising edge of PPS.

2.5.5.2 GPS Time Synchronization Usage

The GPS_REC interface of Ruby Plus LiDAR adopts the RS232 electrical level protocol. Refer to Table 3 for the pin definition.

Table 3 Product Time Synchronization Pin Definitions

Communication	Receiving Pin Definition	
	GPS REC	GPS PULSE
RS232	RS232 Receives serial data with RS232 electrical level standard output from the GPS module	Receives positive synchronization pulse signal output from the GPS module, with a voltage requirement of 3.0 ~ 15.0 V

The external GPS module needs to set the output serial port baud rate to 9600 bps, 8 data bits, no parity bit, and 1 stop bit. Ruby Plus only reads GPRMC-formatted data sent by the GPS module. The standard format is as follows:

\$ GPRMC,<1>,<2>,<3>,<4>,<5>,<6>,<7>,<8>,<9>,<10>,<11>,<12> * hh

<1> UTC time

<2> Positioning status: A = valid positioning, V = invalid positioning

<3> Latitude

- <4> Latitude hemisphere N (Northern Hemisphere) or S (Southern Hemisphere)
- <5> Longitude
- <6> Longitude hemisphere E (Eastern Hemisphere) or W (Western Hemisphere)
- <7> Ground speed
- <8> Ground course
- <9> UTC date
- <10> Magnetic declination
- <11> Magnetic declination direction: E (East) or W (West)
- <12> Mode indication (A = Autonomous positioning, D = Differential, E = Estimated, N = Data invalid)

*hh at the end represents the XOR sum of characters from \$ to *

 Note:

- 1) The GPS_REC interface specification on the Ruby Plus power box is JST S12B-J11DK-TXR, with pin definitions shown in Table 8.
- 2) The interval for sending 1 PPS pulse should be controlled within $1s \pm 200$ us.
- 3) Time synchronization through GPS_REC is only allowed when the positioning status in the GPRMC message is valid (A).
- 4) Ruby Plus is compatible with most GPRMC message formats from GPS modules available in the market. If any compatibility issues are found during use, please contact RoboSense.

2.5.5.3 PTP Synchronization Principle

PTP (Precision Time Protocol, IEEE 1588V2 protocol) is a time synchronization protocol used for high-precision time synchronization between devices. It can also be used for frequency synchronization between devices. Compared to various existing time synchronization mechanisms, PTP offers the following advantages:

- 1) Compared to NTP (Network Time Protocol), PTP can meet higher precision time synchronization requirements. NTP generally achieves sub-millisecond level time synchronization accuracy, while PTP can reach sub-microsecond level accuracy.
- 2) Compared to GPS (Global Positioning System), PTP has lower construction and maintenance costs.

2.5.5.4 gPTP Synchronization Principle

gPTP (general Precise Time Protocol, IEEE 802.1AS protocol) is a derivative protocol of PTP in Time-Sensitive Networking (TSN). The synchronization mechanism uses the same P2P peer delay mechanism as the PTP protocol and adopts Ethernet L2 layer communication. Unlike PTP, gPTP requires the use of hardware-based timestamps, i.e., hardware timestamps, so the requirements for switches and master clocks are more stringent, complying with the IEEE 802.1AS protocol.

2.5.5.5 PTP/gPTP Wiring Method

To use PTP/gPTP synchronization, the following preparations are required. Refer to section 3.4 of the product manual for connection details:

- 1) Select PTP/gPTP mode in the Web interface. See section 4.2 of the product manual for details.
- 2) PTP Master/gPTP Master time source (plug and play, no additional configuration required).
- 3) Ethernet switch.
- 4) Devices that support PTP/gPTP protocols and need time synchronization.

 Note:

- 1) The PTP Master device is a third-party device and is not included in the RoboSense shipment. The user needs to purchase it separately.
- 2) RoboSense products, as Slave devices, only receive time from the Master and do not judge the accuracy of the Master's clock source. If there are sudden changes in the time when parsing LiDAR point cloud data, please check if the time provided by the Master is accurate.
- 3) After LiDAR synchronization, when the Master is disconnected, the time in the point cloud data packet will be accumulated based on the LiDAR's internal clock. The time will be reset when the LiDAR is powered off and restarted.

3 Product Installation

3.1 Accessory Description

The standard accessories included with Ruby Plus LiDAR are listed in Table 4 for reference.

Table 4 Standard Accessory List

No.	Accessory Name	Specification	Quantity
1	LiDAR	Ruby Plus	1
2	Interface Box	3m cable length	1
3	Power Adapter	DC12 V × 3.34 A /40 W	1
4	Power Cable	1.2 m	1
5	Ethernet Cable	1.5 m	1
6	Screw Pack	M4 × 15	3
		M4 × 20	3
7	4 pin Airline	Options: 3m / 4m / 6m / 12m	1
8	16 pin Airline	Options: 3m / 4m / 6m / 12m	1
9	Product Packing List and Shipment Inspection Report	/	1

 For specific requirements, refer to the commercial agreement.

3.2 Mechanical Installation

The structural installation diagram of the LiDAR is shown in Figure 6 .

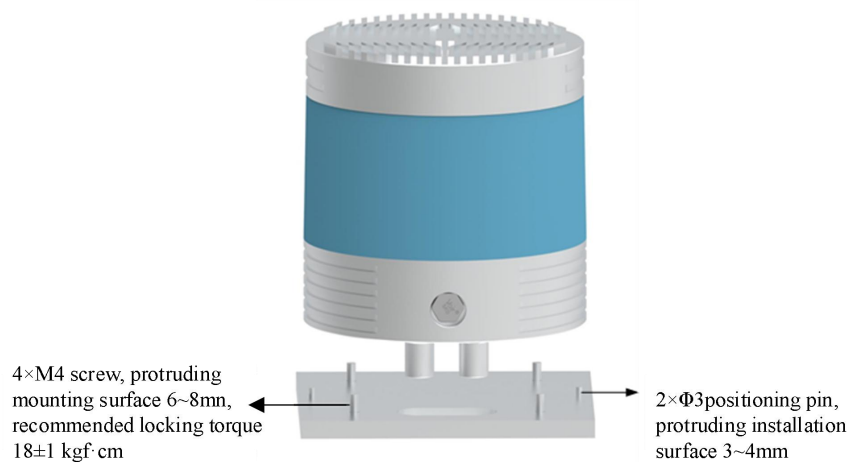

Figure 6 LiDAR Structural Installation Diagram

1) Screw Specifications:

GB / T70.1, M4 × 10, internal hexagon cup head, A2 - 70 stainless steel.

2) Installation Requirements:

- a) The installation surface flatness should be better than 0.2 mm.
- b) The bottom surface should be installed with 4 M4 screws, with an installation surface protrusion of 6 ~ 8 mm. It is recommended to apply a locking torque of 18 ± 1 kgf.cm.
- c) The bottom surface should be installed with 2 $\phi 3$ positioning pins, with a height not exceeding 4 mm.
- d) The installation angle of the LiDAR should not exceed 15° .
- e) During the installation of the LiDAR, if there are contact-type mounting surfaces both above and below the LiDAR, please ensure that the distance between the mounting surfaces is greater than the height of the LiDAR to avoid squeezing the LiDAR.
- f) When routing the cables during LiDAR installation, do not make the cables too tight (leave at least 2 cm of installation margin) to ensure that the cables have some relaxation.

3) Bracket rigidity and strength requirements:

- a) The fixed bracket should have good rigidity to securely install and fix the LiDAR, and maintain the LiDAR in a stable state under various working conditions. Therefore, the first-order modal frequency of the LiDAR and its fixed bracket should be at least greater than 50 Hz.
- b) The LiDAR will undergo various random vibrations and mechanical impacts during use. Under these conditions, the bracket needs to withstand large loads, so the bracket material should be aluminum alloy (thickness above 5 mm) or galvanized steel plate (thickness above 3 mm). Additionally, reinforcement should be added in various directions to increase its rigidity and strength. Try to avoid designing structures with sharp corners, less than 0.3 mm radii, notches, or other stress concentration areas. The strength of the

bracket needs to be verified through simulation.

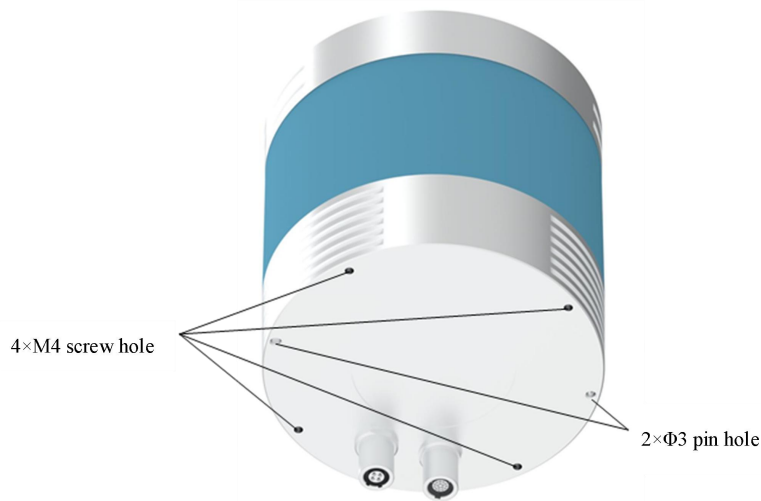

Figure 7 LiDAR Bottom Locator Pin and Screw Diagram

- 4) Heat dissipation requirements:
- a) The bracket material is recommended to be made of aluminum alloy or galvanized steel with a thermal conductivity greater than 50 W/m·K. Heat fins should be added on the bracket, and the spacing, height, and direction of the fins should be controlled reasonably to increase the heat dissipation area. The direction should be consistent with the air convection direction for more effective heat dissipation.
 - b) Ensure that the LiDAR base or top cover is not covered by non-metallic materials to avoid affecting the overall heat dissipation, which may lead to excessive temperature rise of the LiDAR.

3.3 Interface Description

3.3.1 Aviation Plug Interface and Definitions

Ruby Plus uses 2 aviation plug interfaces as shown in Figure 8 and Figure 9 .

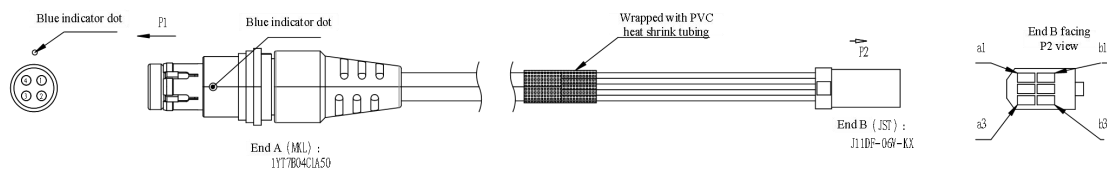

Figure 8 4-core Aviation Plug

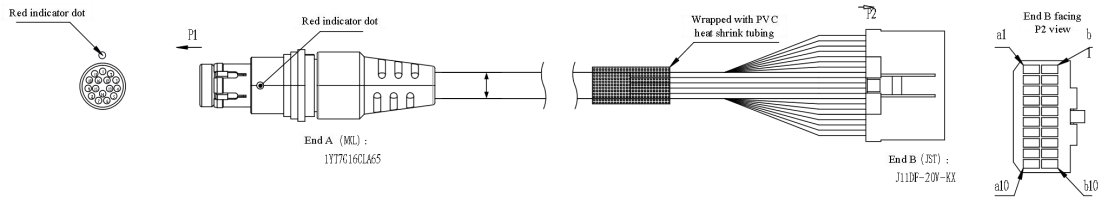

Figure 9 6-core Aviation Plug

The pin definitions for the Ruby Plus aviation plug interfaces are listed in Table 5 and Table 6.

Table 5 4-core Aviation Plug Interface Definition

A-end Pin No.	Color	Definition	B-end Pin No.
1	Red	TRD_P	a1
2	Black	TRD_N	b1
3	White	PGND	a2
4	Green	PGND	b2
Shell	Shielding Layer	PGND	a3
			b3

Table 6 16-core Aviation Plug Interface Definition

A-end Line No.	Color	Definition	B-end Line No.
1	Blue	Power	a1
2	Blue/White	Power	b1
3	Pink	Power	a2
4	Gray	Power	b2
5	Red	GND	a3
6	Red/White	GND	b3
7	Black	GND	a4
8	Black/White	GND	b4
9	Green	/	a5
10	Green/White	/	b5
11	Purple	PPS	a6
12	Purple/White	GPRMC	b6
13	Orange	SYNC_OUT 1	a7
14	Orange/White	SYNC_OUT 2	b7
15	Brown	SYNC_OUT 3	a8
16	Brown/White	PGND	b8
Shell	Shielding Layer	/	/
		/	/
/	/	/	a10
/	/	/	b10

3.3.2 Interface Box

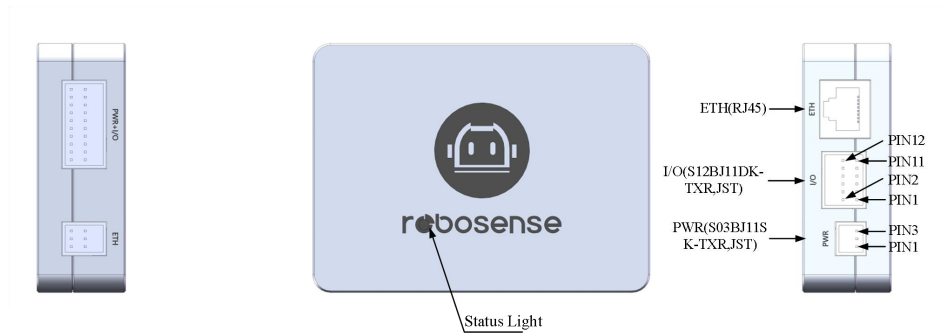

Figure 10 Interface Box Schematic

Figure 10 shows the schematic diagram of the interface box for Ruby Plus. The accessory interface box is equipped with a power indicator light and various interfaces, as shown in Figure 10. It can be connected to power input, RJ45 Ethernet port, and GPS input cable (for the version with the aviation plug interface box, the cable length is 3 meters; for other cable length requirements, please contact RoboSense). The specifications of the interfaces on the power box are detailed in Table 7-Table 9.

Table 7 Power Interface Definitions

Pin No.	Color	Definition
1	Black	GND
2	Black	GND
3	Blue	Power

Table 8 I/O Port Definitions

Pin No.	Color	Definition
1	Blue	+5 V (Output)
1	Orange	SYNC_OUT_1
2	Purple	GPS_PPS
4	Orange	SYNC_OUT_2
5	Purple	GPRMC
6	Brown	SYNC_OUT_3
7	Red	GND
8	/	/
9	Red/White	GND
10	/	/
11	Black/White	GND
12	/	/

Table 9 Power Box Specifications

Serial No.	Interface Name	Specifications/Model (Output End)	Specifications/Model (Connected to LiDAR End)
1	Power Input	JST S03B-J11SK-TXR	JST S20B-J11DK-TXR
2	I/O Interface	JST S12B-J11DK-TXR	
3	Network Interface	Standard RJ45	JST S06B-J11Dk-TXR

3.3.3 Power Interface

Ruby Plus uses JST S03B-J11SK-TXR model connectors for the power interface and comes with a standard DC 5.5-2.1 adapter cable. When the power is correctly input, the green indicator light remains on. If the green indicator light goes off, please check if the power input is normal. If the power input is normal and the interface box is still not working, the interface box may be damaged. In that case, please contact RoboSense.

3.3.4 I/O Interface

The interface box for Ruby Plus defines various interfaces and their corresponding positions as shown in Table 7 and Table 8: SYNC_OUT_1, SYNC_OUT_2, and SYNC_OUT_3 are angle trigger functions that can trigger the camera to take photos. PPS+GPRMC provides GPS time synchronization function. +5 V can be used to power the GPS.

Important Note:

When connecting Ruby Plus "Ground" to an external system, the negative pole ("Ground") of the external system's power supply and the "Ground" of the GPS system must be non-isolated common ground systems.

3.3.5 RJ45 Ethernet Port

Ruby Plus supports T1 automotive Ethernet. When using the power box, the network interface uses a standard RJ45 connector.

3.4 Quick Connection

The Ruby Plus network parameters can be configured, and the default factory setting uses fixed IP and port number mode, as shown in Table 10.

Table 10 Default Factory Network Configuration Table

Device	IP Address	MSOP Package Port Number	DIFOP Package Port Number
Ruby Plus	192.168.1.200	6699	7788
Computer	192.168.1.102		

When using the product, the user needs to set the computer's IP address to be in the same subnet as the product, for example, 192.168.1.x (where x can be any value between 1 and 254), and the subnet mask is 255.255.255.0. For unknown product network configuration information, please connect the product and use Wireshark to capture the output package of the product for analysis. The IP configuration and connection methods are as follows:

1) Connecting the LiDAR

The connection method is shown in Figure 11 .

- a) Connect the LiDAR and Interface Box using the aviation plug.
- b) Connect the PC and Interface Box using the RJ45 Ethernet port.
- c) After powering on, under normal working conditions, the red and green power indicator lights on the LiDAR's Interface Box will be constantly on. The positions of the indicator lights are shown in Figure 10 .

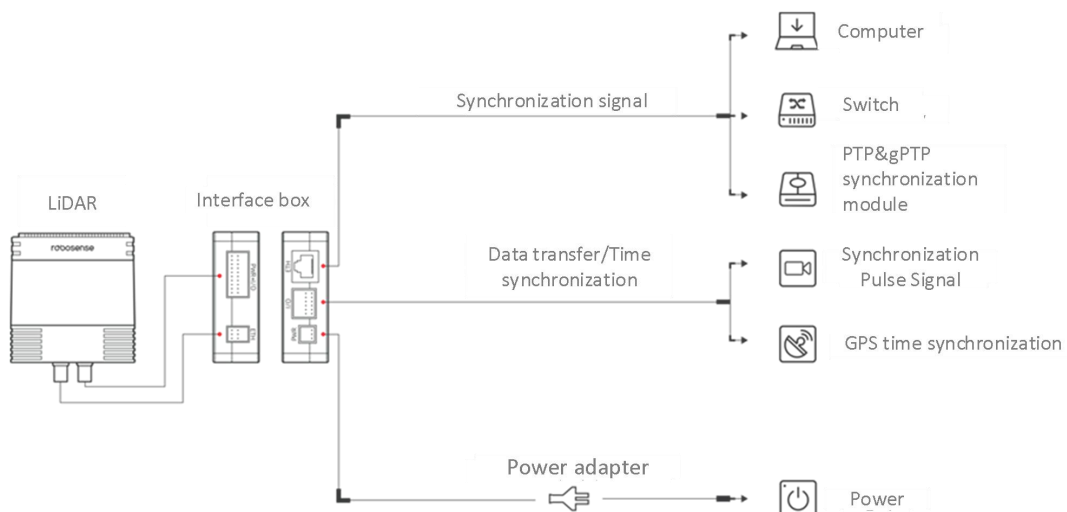
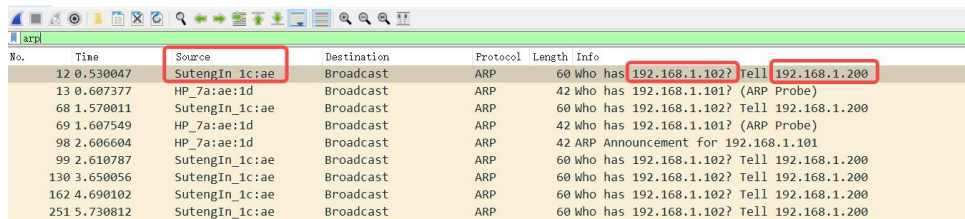

Figure 11 Interface Box Connection Diagram

- 2) Through the ".pcap" packets captured by Wireshark software, get the Local

IP of Computer by analyzing "arp" packets

- a) Perform the following steps after the LiDAR and PC are connected:
- b) Start Wireshark (a third-party network analysis tool) and select the correct network interface to begin capturing packet.
- c) Use the search box in Wireshark and enter "arp" to search for the mutual addressing packets between the LiDAR and PC, as shown in Figure 12 .



No.	Time	Source	Destination	Protocol	Length	Info
12	0.530047	SutengIn_1c:ae	Broadcast	ARP	60	who has 192.168.1.102? Tell 192.168.1.200
13	0.607377	HP_7a:ae:1d	Broadcast	ARP	42	who has 192.168.1.101? (ARP Probe)
68	1.570011	SutengIn_1c:ae	Broadcast	ARP	60	who has 192.168.1.102? Tell 192.168.1.200
69	1.607549	HP_7a:ae:1d	Broadcast	ARP	42	who has 192.168.1.101? (ARP Probe)
98	2.606604	HP_7a:ae:1d	Broadcast	ARP	42	ARP Announcement for 192.168.1.101
99	2.610787	SutengIn_1c:ae	Broadcast	ARP	60	who has 192.168.1.102? Tell 192.168.1.200
130	3.650056	SutengIn_1c:ae	Broadcast	ARP	60	who has 192.168.1.102? Tell 192.168.1.200
162	4.690102	SutengIn_1c:ae	Broadcast	ARP	60	who has 192.168.1.102? Tell 192.168.1.200
251	5.730812	SutengIn_1c:ae	Broadcast	ARP	60	who has 192.168.1.102? Tell 192.168.1.200

Figure 12 Analyzing ARP Packets

- d) In Figure 12 , the "SutengIn" in the Source column indicates the source information of the LiDAR, indicating that the Source IP is 192.168.1.200, which is the LiDAR's IP. The request is accessing 192.168.1.102, which is the PC's IP. If the local IP is not the requested access IP, then configure the PC's local IP as 192.168.1.102 as shown in step 3. If the access is successful, proceed to step 4.
- 3) Configuring the PC's Local IP
 - a) In the Control Panel, go to "Network and Internet" and then "Network and Sharing Center." In the "View your active networks" section, click on the corresponding Ethernet connection to enter the corresponding "Ethernet Status," and then click on "Properties."
 - b) Double-click "Internet Protocol Version 4 (TCP/IPv4)" to enter the IP information settings and use a static IP for configuration.
 - c) Set the local IP address to 192.168.1.102, subnet mask to 255.255.255.0, and click "OK" to complete the PC's static IP setting.
 - 4) Connection Completed

i Note:

- 1) The time synchronization module (PTP & gPTP, GPS time synchronization module) is not included as a standard product. If you need to use these features,

please purchase them separately and follow the connection method shown in Figure 11 .

- 2) The configuration of the local static IP provided above is only an example for Windows operating systems. For other operating systems, please refer to the actual instructions.

4 Product Usage

4.1 Product Coordinate System

The coordinates and rotation direction of the product are shown in Figure 13 .

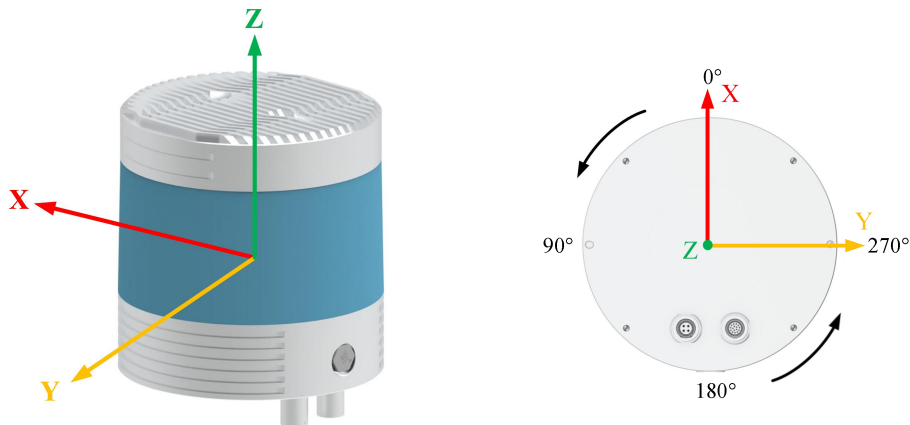

Figure 13 LiDAR Coordinate and Rotation Direction Illustration

i Note:

The coordinate origin of the LiDAR is defined at the center of the LiDAR's structure, with a height distance of 73.5 mm from the base.

4.2 Web UI Usage

4.2.1 Web UI Functions

Ruby Plus only supports parameter setting, viewing of operational information/status, and firmware upgrades through the web interface.

The Ruby Plus web address changes according to the Device IP. The default Device IP is 192.168.1.200. If you have changed the Device IP, the web address will be the newly set IP.

4.2.2 Accessing the Web UI Interface

Once the product is connected and correctly configured as required, use a computer browser to access the product's IP address (default Device IP: 192.168.1.200) to enter

the Ruby Plus web homepage. The default page is the "Device" tab.

4.2.3 Using the Web UI Interface

For detailed instructions on using the Web UI interface, please refer to Appendix A of the product manual.

4.3 RSVIEW Usage

For data visualization with Ruby Plus, you can use free tools such as Wireshark and tcp-dump to obtain raw data. RSVIEW can provide a more convenient way to visualize the raw data.

4.3.1 Software Functions

RSVIEW enables real-time visualization of Ruby Plus data. It can also replay data saved in ".pcap" file format, but does not support ".pcapng" files at the moment.

In RSVIEW, the distance measurement values obtained by Ruby Plus are displayed as points. It supports various custom colors to display data, such as reflection intensity, time, distance, horizontal angle, and laser beam index. The displayed data can be exported and saved in ".csv" format, and RSVIEW version 3.1.3 and later versions support exporting data in ".las" format.

RSVIEW includes the following features:

- 1) Real-time display of data via Ethernet.
- 2) Save real-time data as PCAP files.
- 3) Replay data from recorded PCAP files.
- 4) Various visualization modes, such as distance, time, horizontal angle, etc.
- 5) Display point data in tabular format.
- 6) Export point cloud data as CSV files.
- 7) Distance measurement tool.
- 8) Display multiple frames of replayed data simultaneously.
- 9) Show or hide individual laser beams from Ruby Plus.

10) Clipping display.

4.3.2 Installing RSView

RSView can be run on Windows 64-bit and Ubuntu 18.04 or higher operating systems. You can download the latest version of RSView software compressed package from the Robosense official website (<http://www.robosense.cn/resources>). After downloading, make sure the extraction path does not contain Chinese characters. The software does not require installation; simply run the executable file after extraction to use it.

4.3.3 Using RSView

After opening RSView, you can access the user guide by pressing the F1 button or by clicking on the "RS-LiDAR User Guide" option in the Help menu.

4.4 Communication Protocols

Ruby Plus communicates with a computer via Ethernet using UDP (User Datagram Protocol). The communication protocols between Ruby Plus and the computer fall into two categories, as described in Table 11.

Table 11 Protocol Overview

Protocol Name	Abbreviation	Function	Type	Packet Size	Send Interval
Main data Stream Output Protocol	MSOP	Point cloud data	UDP	1248 bytes	Approx. 167 us
Device Information Output Protocol	DIFOP	LiDAR information output	UDP	1248 bytes	Approx. 1 s

 Note:

- 1) Section 4.4 of the product manual describes and defines the payload (1248 bytes) of the protocols.
- 2) The Main Data Stream Output Protocol (MSOP) encapsulates the laser scanning data, including distance, angle, and reflection intensity, into packets for output.
- 3) The Device Information Output Protocol (DIFOP) outputs various configuration information about the current state of Ruby Plus.

4.4.1 MSOP and DIFOP Data Protocols

The UDP packets sent by Ruby Plus have a payload of 1248 bytes. The data structure for the Main Data Stream Output Protocol (MSOP) and Device Information Output Protocol (DIFOP) is shown in Figure 14 .

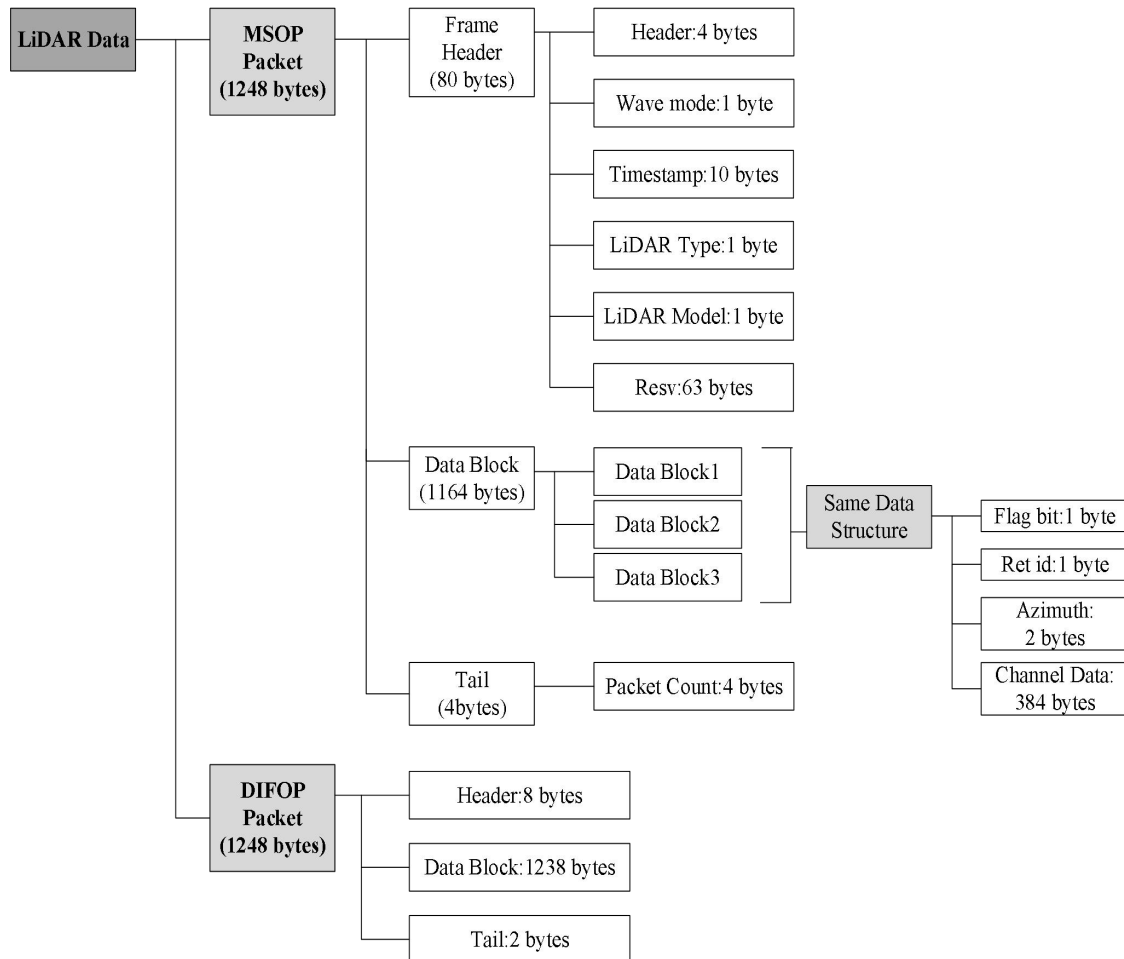

Figure 14 LiDAR Data Structure Illustration

4.4.2 Main Data Stream Output Protocol (MSOP)

Main Data Stream Output Protocol, abbreviated as MSOP, is used for product output and computer parsing. The default port number is 6699.

4.4.2.1 Header

The header consists of 42 bytes and is used to identify the start of the data. The data structure details are shown in Table 12.

Table 12 MSOP Header Data Table

Header (80 bytes)			
Field	Offset	Length(bytes)	Description
Header ID	0	4	4 bits used for data packet header detection, 4 bytes defined as 0x55, 0xAA, 0x05, 0x5A.
Reserved	4	3	/
Return Mode	7	1	0x01: Single Return, 0x03: Dual Return
Reserved	8	2	/
Timestamp	10	10	Stores the timestamp with a resolution of 1 μ s. Details in Appendix C.12 in the product manual.
Reserved	20	11	/
LiDAR Type	31	1	Used to indicate the LiDAR series. 0x05: Ruby Plus
Reserved	32	48	/

i Note:

The defined timestamp is used to record the system time with a resolution of 1 us. For specific details, refer to Appendix C.13 in the product manual for time definition.

Table 13 Return Mode and Return Number Correspondence

Definition Mode	Return Mode	Return Number
Single Return	1	d1
Dual Return	3	d1, d2; d1, d2...

4.4.2.2 Data Block Interval

The data block is the measurement part of the MSOP packet and consists of 1164 bytes. It contains 3 Data blocks, each 388 bytes long, representing a complete set of ranging data.

Within each Data Block, there is a space of 100 bytes, including a 2-byte flag represented by 0xffee, a 1-byte Return ID (Ret_id) indicating the return sequence, and a 2-byte Azimuth value representing the horizontal rotation angle. Each azimuth value corresponds to 128 channel data, which includes one complete set of 128 channels.

Table 14 Data Block Packet Definition

说明	数据块(1200 bytes)		
数据块序号	Data Block 1	Data Block 2	Data Block 3
标志位	0xfe	0xfe	0xfe
回波序号	Ret_id	Ret_id	Ret_id
水平旋转角	Azimuth 1	Azimuth 2	Azimuth 12
通道 1	Channel data 1	Channel data 1	Channel data 1
通道 2	Channel data 2	Channel data 2	Channel data 2
...
通道 127	Channel data 127	Channel data 127	Channel data 127
通道 128	Channel data 128	Channel data 128	Channel data 128

i Note:

In Dual Return Mode, the first column of 128 channel data stores the last return, and the second column stores the strongest return.

1) Channel Data Definition

The channel data, Channel data, is represented by 3 bytes. The high two bytes represent the distance information, and the low byte represents the reflectivity information, as shown in Table 15.

Table 15 Channel Data Representation

Channel data (3 bytes)		
2 bytes Distance		1 byte Reflectivity
Distance1 [15:8]	Distance2 [7:0]	Reflectivity(Reflectivity information)

i Note:

Distance is represented by 2 bytes with a resolution of 0.5 cm.

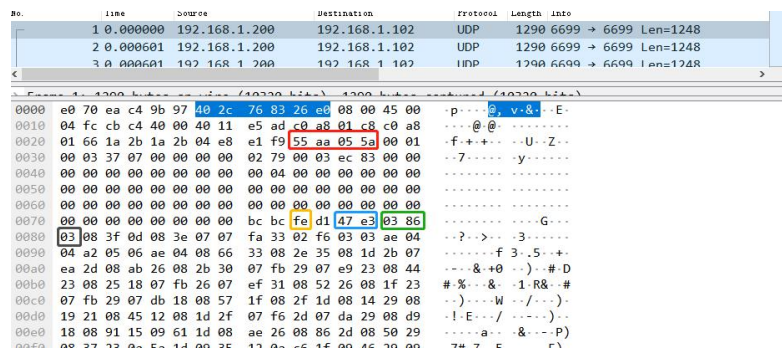

Figure 15 MSOP Packet Illustration

Red Box: Header ID;

Yellow Box: Data Block Flag;

Blue Box: Azimuth value of Channel data 1;

Green Box: Distance value of Channel data 1.

The distance value in the data packet can be calculated as follows:

- a) Hexadecimal representation of the distance value in the packet: 0x03, 0x86;
- b) Convert the distance value to decimal: 902;
- c) Perform calculations based on a distance resolution of 0.5 cm;
- d) Result: $902 \text{ m} \times 0.5 / 100 = 4.51 \text{ m}$.

The angle value in the data packet can be calculated as follows:

- a) Hexadecimal representation of the angle value in the packet: 0x47, 0xe3;
- b) Convert the angle value to decimal: 18403;
- c) Divide the converted decimal value by 100;
- d) Result: $18403^\circ / 100 = 1184.03^\circ$.

2) Angle Value Definition

In each Data Block, Ruby Plus outputs the angle value corresponding to the first channel's laser ranging time. The angle value is derived from the angle encoder, where the zero position of the angle encoder corresponds to the zero angle, and the horizontal rotation angle resolution is 0.01° .

4.4.2.3 Tail

The Tail has a length of 4 bytes, used for packet count.

4.4.3 Device Info Output Protocol (DIFOP)

The Product Information Output Protocol, also known as DIFOP, is an "output-only" protocol designed to regularly send product-related information, including serial number (S/N), firmware version information, configuration, angle information, operational status, and fault diagnosis, to users. Users can read DIFOP to interpret specific information about the currently used product.

A complete DIFOP Packet's data format structure consists of a sync Header, Data area, and Tail. Each data packet is 1248 bytes in total: 8 bytes for the sync Header, 1238 bytes for the Data area, and 2 bytes for the Tail. The basic structure of the data packet is shown in Table 16.

Table 16 Data Format Structure of DIFOP Packet

Section	Index	Information	Offset	Length (byte)	Remarks	
Header	0	DIFOP Identifier	0	8	a5_ff_00_5a_11_11_55_55	
Data	1	Motor Speed Setting	8	2	Appendix C.1	
	2	Ethernet	10	22	Appendix C.2	
	3	FOV Setting Value	32	4	Appendix C.3	
	4	Reserved	36	2	/	
	5		Motor Phase Lock	38	2	Appendix C.4
			Mainboard Firmware Version	40	5	Appendix C.5
			Baseboard Firmware Version	45	5	Appendix C.6
			APP Software Version	50	5	Appendix C.7
			Motor Firmware Version	55	5	Appendix C.8
			Reserved	60	3	/
			Web CGI Version	63	4	Appendix C.9
	6	Reserved	67	16	/	
	7		Ethernet Gateway	83	4	IPv4 format
			Subnet Mask	87	4	
	8	Reserved	91	201	/	
	9	Product Serial Number	292	6	Appendix C.10	
	10	Reserved	298	2	/	
	11	Return Mode	300	1	Section 2.5.3	
	12	Time Sync Info	301	2	Appendix C.11	
	13	Time	303	10	Appendix C.12	
	14	Operating Status	313	24	Appendix C.13	
	15	Forward/Reverse Flag	337	1	Forward: 0x00, Reverse: 0x01	
16	Reserved	338	13	/		
17	Fault Diagnosis	351	24	Appendix C.14		
18	Reserved	375	7	/		
19	GPRMC	382	86	Appendix C.15		
20	Vertical Calibration Angle	468	384	Appendix C.16		
21	Horizontal Calibration Angle	852	384	Appendix C.17		
22	Reserved	1236	10	/		
Tail	23	Frame Tail	1246	2	0f_f0	

 Note:

- 1) The Header (DIFOP Identifier) content is 0xA5, 0xFF, 0x00, 0x5A, 0x11, 0x11, 0x55, 0x55, and can be used as a check sequence for the packet. The Tail (Frame Tail) content is 0x0F, 0xF0.
- 2) The definition and usage of each item's register can be found in Appendix C of the product manual, and the corresponding relationships are detailed in the Remarks column of Table 16.

5 Product Maintenance

5.1 Transportation and Logistics

! Important

Improper transportation can cause product damage!

- 1) The product should be packaged with shockproof and moisture-proof materials to avoid damage during transportation. It is recommended to use the original packaging;
- 2) Handle with care during transportation to avoid impact or dropping;
- 3) When receiving the goods, carefully check the delivery list for any damages (including the product and packaging);
- 4) If there is any transportation damage, refuse to accept the delivery and contact RoboSense promptly.

5.2 Storage

! Important

Improper storage may cause product damage!

- 1) Store the product in an indoor environment with normal temperature and dry conditions;
- 2) Handle the product gently to avoid impact or dropping;
- 3) The product should be stored in a safe environment to avoid corrosion, mechanical impact, or exposure to environments exceeding the protection level;
- 4) Regularly inspect the condition of all components and packaging, and it is recommended to check every three months.

5.3 Product Cleaning

To ensure accurate perception of the surrounding environment, keep the RS-LiDAR's circular protective cover clean.

5.3.1 Precautions

- ❗ Before cleaning the RS-LiDAR, carefully read and understand the content of this section. Improper cleaning may damage the product.
- ❗ When using the LiDAR in harsh environmental conditions, clean the surface regularly to keep the LiDAR clean. Otherwise, it may affect the normal operation of the LiDAR.

5.3.2 Required Materials

- 1) Clean and dust-free cloth;
- 2) Neutral solution at moderate temperature (such as soapy water, distilled water, 99% concentration of ethanol, etc.).

5.3.3 Cleaning Method

- 1) If the LiDAR surface is only covered with some dust:
 - a) Use a clean and dust-free cloth, dip it in a small amount of neutral solution;
 - b) Gently wipe the LiDAR surface;
 - c) Dry it with a clean and dry dust-free cloth.
- 2) If the LiDAR surface is covered with mud or other solid foreign objects:
 - a) First, spray clean water on the dirty part of the LiDAR surface to remove the mud or foreign objects (Note: Do not directly wipe off the mud with a dust-free cloth, as it may scratch the surface, especially the protective cover);
 - b) Then spray warm soapy water on the dirty part. The lubricating effect of the soapy water helps to remove the foreign objects. Gently wipe the LiDAR surface with a fiber cloth, but be careful not to scratch the surface;
 - c) Finally, rinse off the residual soap on the LiDAR surface with clean water (if there is still residue, clean it again with 99% ethanol) and dry it with a clean and dry dust-free cloth.

6 Fault Diagnosis

This chapter lists some common problems encountered during the use of the product and their corresponding troubleshooting methods. For details, refer to Table 17.

Table 17 Common Fault Troubleshooting Methods

Fault Phenomenon	Solution
Red/Green Indicator Light on the Interface Box is Not On/Flashing	Check if the connection line between the interface box and the power supply terminal is loose; Check if the cable harness is damaged.
The Product Motor Does Not Rotate	Check if the indicator light on the interface box is normal; Check if the connection line between the interface box and the power supply/product terminal is loose and if the cable harness is damaged.
The Product Keeps Restarting During Startup	Check the input power connection and polarity; Check if the voltage and current of the input power meet the requirements (when 12V voltage is applied, the input current should be $\geq 2A$); Check if the installation plane of the product is level or if the screws on the bottom of the LiDAR are tightened too tightly.
The Product Internally Rotates, But There is No Data	Check if the LiDAR emits light normally; Check if the network connection is normal; Confirm if the computer-side network configuration is correct; Use other software (such as Wireshark) to check if the data is received; Disable the firewall and other security software that may block the network; Check if the power supply is normal; Try restarting the product.
Wireshark Can Receive Data, But RSView Does Not Display Point Cloud	Close the computer's firewall and run RSView through the firewall; Confirm that the computer's IP configuration matches the destination address set in the product; Confirm that the Sensor Network Configuration in RSView is set correctly; Confirm that the installation directory or configuration file storage directory of RSView does not contain any Chinese characters; Confirm that the data packets received by Wireshark are of

	the MSOP type.
--	----------------

Table 17 (Continuation)

Fault Phenomenon	Solution
The Product Has Frequent Data Loss	<p>Confirm if there is a large number of other network packets or network conflicts in the network;</p> <p>Confirm if there are other network products sending a large amount of data in broadcast mode, causing sensor data blocking;</p> <p>Confirm if the computer's performance and interface performance meet the requirements;</p> <p>Remove all other network products and directly connect to the computer to confirm if data loss occurs.</p>
Unable to Synchronize GPS/PTP/gPTP Time	<p>Confirm if the synchronization mode has been switched to the correct mode on the web page;</p> <p>Under the GPS+PPS time synchronization mode:</p> <p>Confirm if the GPS module's baud rate is 9600 bps, 8 data bits, no parity bit, and 1 stop bit;</p> <p>Confirm if the GPS module outputs 3.3V TTL or RS232 level;</p> <p>Confirm if the 1PPS pulse is continuous and the wiring is correct;</p> <p>Confirm if the NMEA message format of GPRMC is correct;</p> <p>Confirm if the GPS module and interface box share the same ground;</p> <p>Confirm if the GPS module receives a valid fix;</p> <p>Confirm if the GPS module is validly positioned (outdoors);</p> <p>Under the PTP / gPTP time synchronization mode:</p> <p>Confirm if the PTP / gPTP Master synchronization protocol complies with the current PTP / gPTP protocol;</p> <p>Confirm if the PTP / gPTP Master is working properly.</p>
No Data Output After Passing Through the Router	Close the DHCP function of the router or set the IP address of the sensor to the correct IP address internally in the router.
ROS Driver Displays a Fixed Blank Area Rotating When Showing Point Cloud	This phenomenon is normal. It occurs because the ROS driver splits the data into fixed packages for frame display. The blank part of the data will be displayed in the next frame.
RSView software outputs point clouds as a single ray	For Windows 10 systems, set RSView to run in Windows 7 compatibility mode to resolve the issue.

 Note:

If the above troubleshooting steps fail to resolve the issue, please contact RoboSense for further assistance.

7 After-sales Service

If the solutions provided in Chapter 6 of the troubleshooting guide do not solve the problem, please promptly contact RoboSense.

Official Website: <https://www.roboSense.cn/contact>

Email: support@roboSense.cn

Phone: 0755-86325830 / 15338772453

 Additional Information:

- 1) Please wait for a confirmation response from RoboSense after-sales service before sending the product back.
- 2) When sending the product back, please use the original packaging or an equivalent cushioned and moisture-resistant packaging.

Appendix A Web UI Operation

A.1 Product Information

The web interface of the LiDAR provides the default product information page, as shown in Figure 16 :

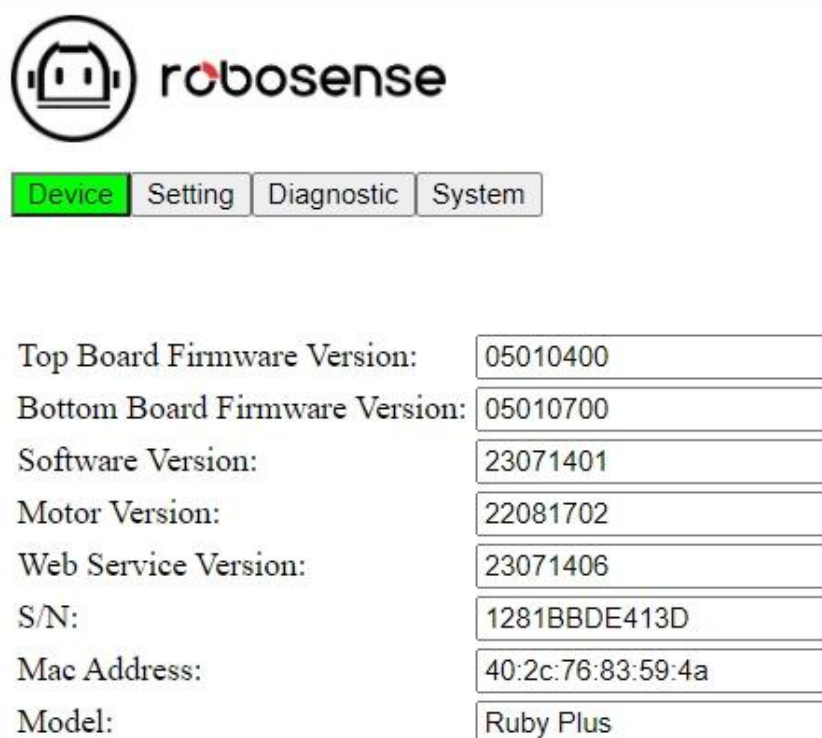

The screenshot shows the RoboSense web interface. At the top left is the RoboSense logo, which consists of a circular icon containing a stylized robot head and the text "robosense" to its right. Below the logo is a navigation menu with four buttons: "Device" (highlighted in green), "Setting", "Diagnostic", and "System". The main content area displays a list of product information items, each with a label and a corresponding text input field containing the value.

Top Board Firmware Version:	05010400
Bottom Board Firmware Version:	05010700
Software Version:	23071401
Motor Version:	22081702
Web Service Version:	23071406
S/N:	1281BBDE413D
Mac Address:	40:2c:76:83:59:4a
Model:	Ruby Plus

Figure 16 Web Interface Home Page

- 1) Top Board: Mainboard firmware version.
- 2) Bottom Board: Baseboard firmware version.
- 3) Software Version: Software version.
- 4) Motor Firmware Version: Motor version.
- 5) S/N: Product serial number.
- 6) Mac Address: MAC address.
- 7) Model: Product name.

A.2 Product Parameter Settings

The "Setting" tab on the web page is the LiDAR parameter setting page where you can change Device IP, Port number, Return mode, Rotation speed, and Angle trigger settings. The illustrations and descriptions are shown in Figure 17 and Figure 19 :

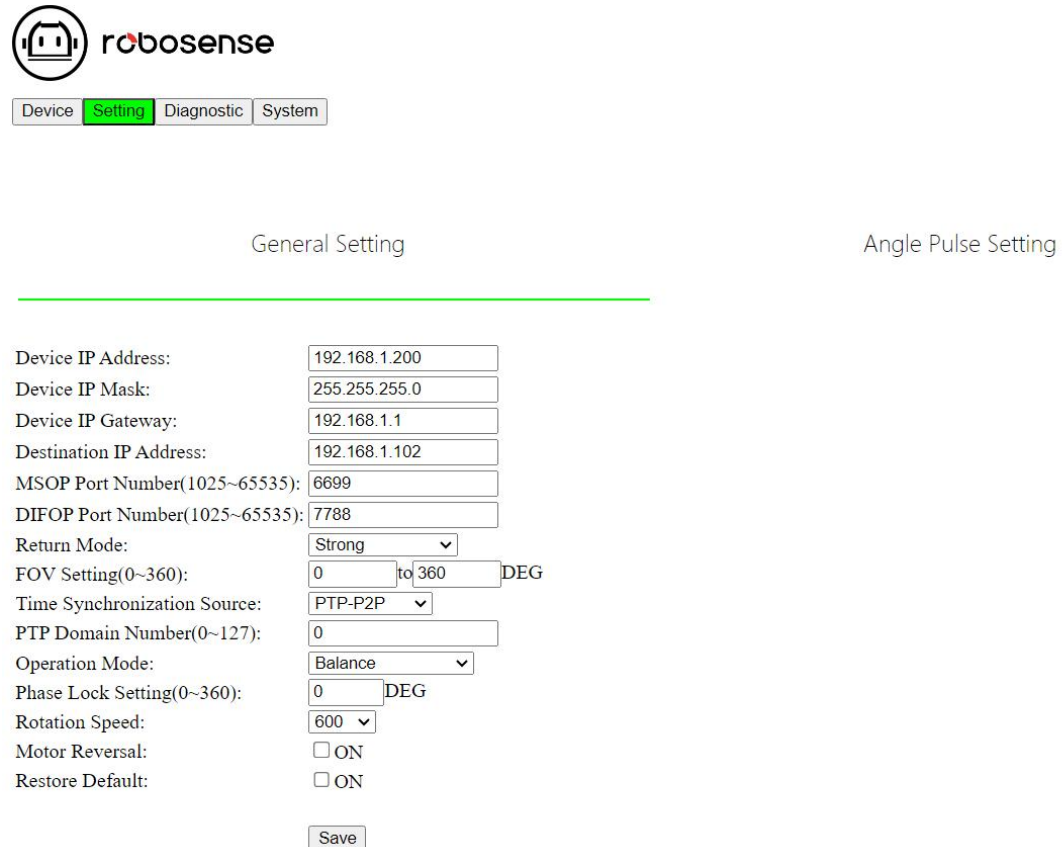

robosense

Device **Setting** Diagnostic System

General Setting Angle Pulse Setting

Device IP Address:

Device IP Mask:

Device IP Gateway:

Destination IP Address:

MSOP Port Number(1025~65535):

DIFOP Port Number(1025~65535):

Return Mode: ▼

FOV Setting(0~360): to DEG

Time Synchronization Source: ▼

PTP Domain Number(0~127):

Operation Mode: ▼

Phase Lock Setting(0~360): DEG

Rotation Speed: ▼

Motor Reversal: ON

Restore Default: ON

Figure 17 Web Interface LiDAR Settings

- 1) Supports Unicast (default)/Broadcast mode. Setting the Destination IP to 255.255.255.255 activates the Broadcast mode. The default factory setting is 192.168.1.102, and IP setting only supports IPv4 format.
- 2) Can modify the data ports for MSOP and DIFOP, with a value range of 1025 to 65535.
- 3) Dropdown option to select the "Return Mode" as Strongest (default)/Last/First/Dual Return modes.
- 4) Can set the Field of View (FOV) with an angle range of 0 to 360°. Once set, only point cloud data within the designated FOV will be output.
- 5) Dropdown option for selecting the "Time Synchronization Source" as GPS,

- PTP-P2P, PTP-E2E, or PTP-gPTP to determine the time synchronization method.
- 6) Dropdown option for selecting the "Operation Mode" as Standby/Balance (default)/High Performance (0.1°). When Standby mode is selected, the radar motor and transmitter stop working.
- 7) Can set "Phase Lock Setting" within the range of 0° to 360°.
- 8) Dropdown option to select the rotation speed, supporting 600 rpm (default) and 1200 rpm.
- 9) "Motor Reversal" controls the motor's clockwise/counterclockwise rotation. Check "ON" and save to enable counterclockwise rotation.
- 10) "Restore Default" resets the configurations. Check "ON" and save to restore the current settings to default.

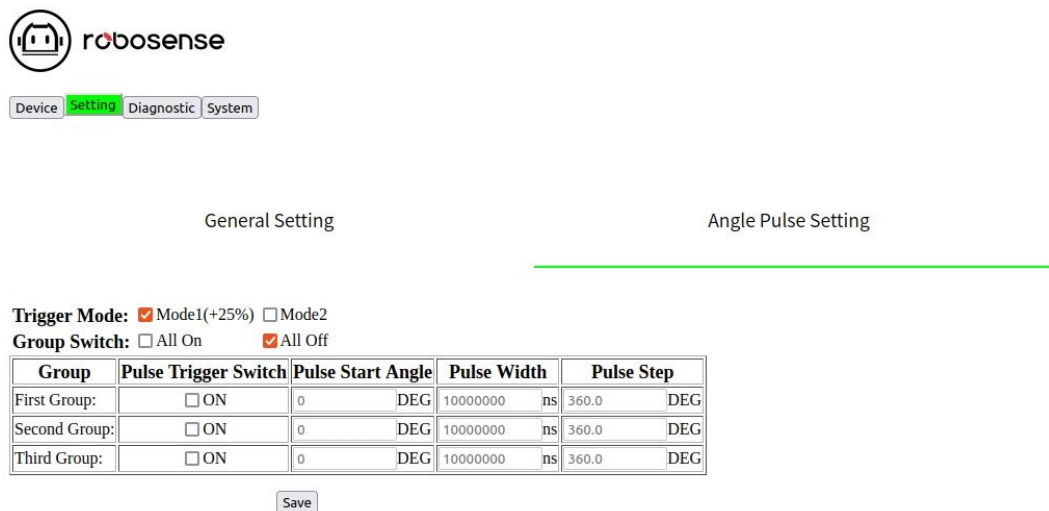

Figure 18 Web UI Angle Trigger Settings

- 1) Angle Pulse Setting: Enable angle trigger settings here. The angle trigger function is disabled by default.
- 2) Trigger Mode: Two start angle modes are available. Mode 1 increases the starting pulse width by 25% (default), while Mode 2 keeps the starting pulse width unchanged.
- 3) Group Switch: Enable/Disable "Pulse Trigger Switch." When "All On" is checked, all SYNC trigger settings are enabled by default. "All Off" is the default setting.
- 4) Group: Corresponds to SYNC OUT groups (SYNC OUT 1 & SYNC OUT 2

within Ruby Plus, but only SYNC OUT 1 is available in the power box). Refer to Table 8 for specific definitions.

- 5) Pulse Trigger Switch: Enable/Disable the trigger function. When "ON" is checked, the options become editable; when "OFF," they become grayed out and uneditable.
- 6) Pulse Start Angle: Set the corresponding starting angle, with a default value of 0°. Input values format must be integer.
- 7) Pulse Width: Set the corresponding pulse width, with a default value of 10 ms. Input values must be multiples of 20 ns, and the duty cycle can go up to a maximum of 50%.
- 8) Pulse Step: Set the corresponding pulse step, the default value format must be floating with resolution of 0.1 degree.

 Note:

- 1) Device IP and Destination IP should be in the same network segment; otherwise, the connection may fail.
- 2) The values for MSOP and DIFOP range from 1025 to 65535, and MSOP port and DIFOP port cannot be set to the same port.
- 3) After making changes, click "Save" to apply the settings. A successful prompt indicates that the settings have taken effect.

A.3 Product Diagnostics / Operating Status

This page allows real-time monitoring of the LiDAR's operating status, including voltage, current, real-time speed, runtime, temperature, and other information, as shown in Figure 19 :

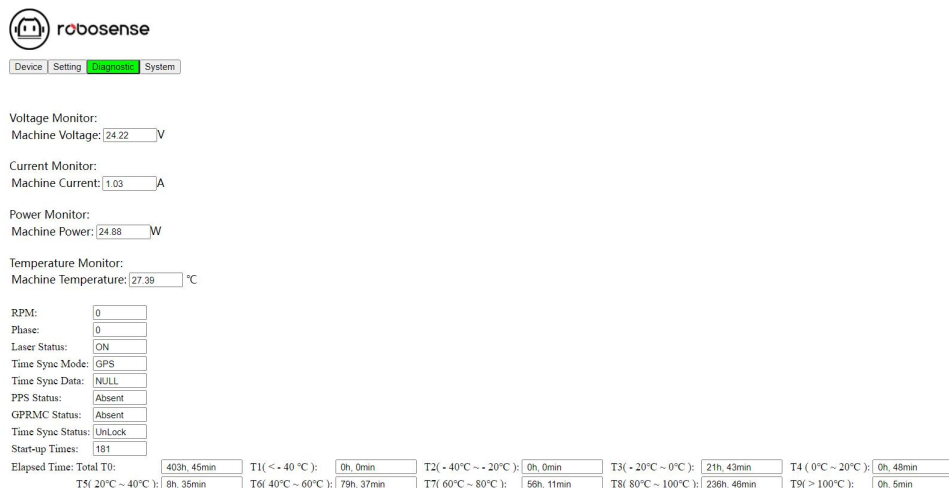

Figure 19 Web Interface Operating Status / Diagnostics

- 1) Voltage Monitor: Monitors the product's voltage. In Standby mode, this section will be highlighted in red.
- 2) Current Monitor: Displays the product's current. In Standby mode, the current will decrease to around 0.2 A.
- 3) Power Monitor: Displays the product's power consumption. In Standby mode, the power consumption will decrease to around 5 W.
- 4) Temperature Monitor: Shows the current operating temperature of the product.
- 5) RPM: Provides real-time information on the product's current rotation speed.
- 6) Phase: Provides real-time information on the product's current phase angle.
- 7) Laser Status: Shows "On" (default) and "Off" states. When Standby mode is selected, it will display "Off."
- 8) Star-up Times: Displays the current total number of product startups. It increases by one each time the power is restarted.
- 9) Elapsed Time Total T0: Displays the total operating time of the product and the accumulated working time under various temperatures.

i Note:

- 1) The page refresh rate is 1 second.
- 2) If the voltage/current section turns red, please check if the product is in Standby mode. If not, check if the product is operating normally.

A.4 Product Firmware Upgrade

Click on the "System" on the web page. This page allows the firmware upgrade for the mainboard, baseboard, software, web interface, and motor. Follow the steps below:

- 1) Contact RoboSense to obtain the upgrade firmware. Once the firmware is ready, click "Choose File," as shown in Figure 20 .



Figure 20 Step 1 - Click "Choose File"

- 2) Select the folder containing the corresponding firmware for the upgrade, then click "Open" (avoid using Chinese characters in the file path), as shown in Figure 21 .

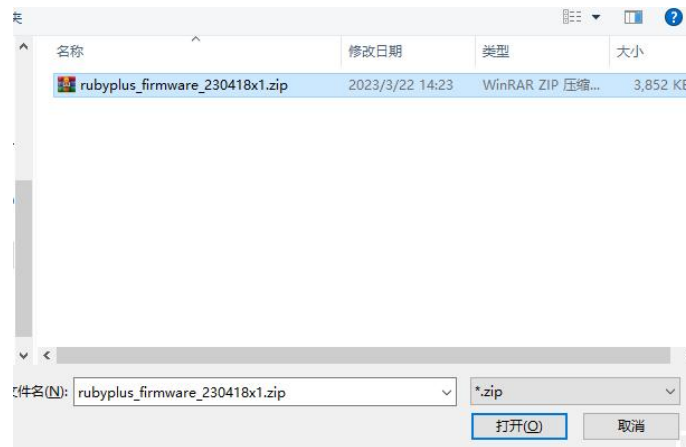

Figure 21 Step 2 - Select Firmware for Upgrade

- 3) After selecting the firmware for upgrade, the filename will change to the selected firmware name, indicating that it is successfully loaded, as shown in Figure 22 . Click "Update" to proceed with the upgrade.



Figure 22 Step 3 - Click "Update"

- 4) The web interface will prompt the upgrade success (or indicate if there is a

duplicate version). The product will automatically restart. After the restart, log in again to the web interface homepage and check the Device section to confirm if the upgrade was successful, as shown in Figure 23 .

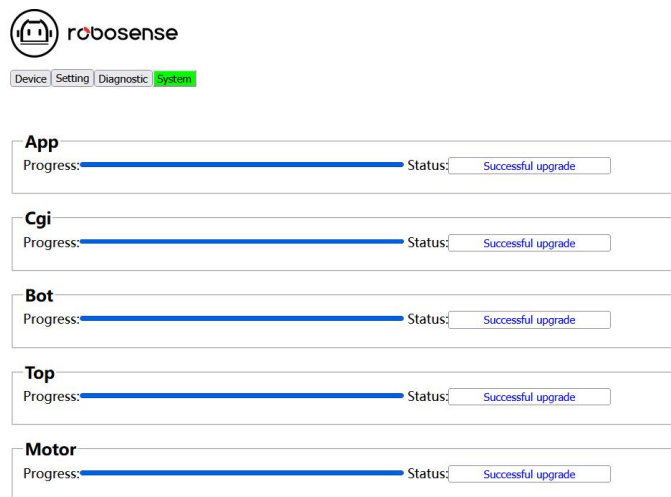

Figure 23 Step 4 - Upgrade Successful

Appendix B ROS & ROS2 Package

rslidar_sdk is the ROS-based driver SDK. You can download it from the RoboSense GitHub repository or contact RoboSense for access.

- 1) rslidar_sdk depends on rs_driver, which is the basic RoboSense driver. Download rs_driver from the GitHub platform.
- 2) If you are using ROS2, rslidar_sdk also depends on rslidar_msg, which defines the message format. Download the msg file from the GitHub platform.
- 3) The SDK package contains comprehensive usage guidelines. Before using the driver SDK, please read the README file and documentation under the doc folder.

 Note:

SDK Download Link: https://github.com/RoboSense-LiDAR/rsLiDAR_sdk

rs_driver Download Link: https://github.com/RoboSense-LiDAR/rs_driver

msg Download Link: https://github.com/RoboSense-LiDAR/rslidar_msg

Appendix C Register Definitions

This appendix provides additional information to section 4.4, defining the various registers in the protocol. All calculations are in big-endian format. The "Value" represents the decimal value obtained after converting the offset bytes.

C.1 Motor Speed (MOT_SPD) Register

Table 18 Motor Speed Register

Motor Speed Register (2 bytes)		
Index	byte 1	byte 2
Function	MOT_SPD	

i Register Description:

- 1) This register is used to read the motor speed setting value.
- 2) For example, if the set value is 600 RPM, and the byte 1 = 0x02 and byte 2 = 0x58, then the Value = 600 RPM.

C.2 Ethernet (ETH) Register

Table 19 Ethernet Register

Ethernet Register (22 bytes)								
Index	byte 1	byte 2	byte 3	byte 4	byte 5	byte 6	byte 7	byte 8
Function	LIDAR_IP				DEST_PC_IP			
Index	byte 9	byte 10	byte 11	byte 12	byte 13	byte 14	byte 15	byte 16
Function	MAC_ADDR						MSOP	
Index	byte 17	byte 18	byte 19	byte 20	byte 21	byte 22	/	/
Function	Reserved		DIFOP		Reserved		/	

i Register Description:

- 1) LIDAR_IP: The source IP address of the LiDAR, occupying 4 bytes.
- 2) DEST_PC_IP: The IP address of the destination PC, occupying 4 bytes.
- 3) MAC_ADDR: The MAC address of the LiDAR.
- 4) MSOP and DIFOP each occupy 2 bytes.

C.3 FOV Setting (FOV_SET) Register

Table 20 FOV Setting Register

FOV Setting Register (4 bytes)				
Index	byte 1	byte 2	byte 3	byte 4
Function	FOV_START		FOV_END	

i Register Description:

- 1) This register is used to read the FOV (Field of View) setting value.
- 2) FOV_START and FOV_END have a range of 0 to 36000, corresponding to angles from 0 to 360°. Details are as follows:
 - a) FOV_START: byte 1 = 0x5d, byte 2 = 0xc0, Value = 24000.
 - b) FOV_END: byte 3 = 0x1f, byte 4 = 0x40, Value = 8000.
 - c) With two decimal places, the FOV range is set to 240° to 80°.

C.4 Motor Phase (MOT_PHASE) Register

Table 21 Motor Phase Register

Motor Phase Register (2 bytes)		
Index	byte 1	byte 2
Function	MOT_PHASE	

i Register Description

- 1) This register is used to read the motor lock phase setting.
- 2) MOT_PHASE ranges from 0 to 360, corresponding to angles from 0° to 360°. Details are as follows:
 - a) MOT_PHASE: byte 1=0x00, byte 2=0x64, Value=100
 - b) Indicates that the motor lock phase is set to 100°.

C.5 Main Board Firmware Version (TOP_FRM)

Table 22 Main Board Firmware Version

Main board firmware version (5 bytes)					
Index	byte 1	byte 2	byte 3	byte 4	byte 5
Function	TOP_FRM				

i Register Description

If byte 1=0x00, byte 2=0x01, byte 3=0x05, byte 4=0x05, byte 4=0x00, then the firmware version is 00 01 05 05 00.

C.6 Bottom Board Firmware Version (BOT_FRM)

Table 23 Bottom Board Firmware Version

Bottom board firmware version (5 bytes)					
Index	byte 1	byte 2	byte 3	byte 4	byte 5
Function	BOT_FRM				

i Register Description

If byte 1=0x00, byte 2=0x02, byte 3=0x01, byte 4=0x03, byte 4=0x00, then the firmware version is: 00 05 01 03 00.

C.7 APP Software Version (SOF_FRM)

Table 24 Software Version

APP software version (5 bytes)					
Index	byte 1	byte 2	byte 3	byte 4	byte 5
Function	SOF_FRM				

i Register Description

If byte 1=0x00, byte 2=0x23, byte 3=0x03, byte 4=0x16, byte 4=0x01, then the firmware version is: 00 23 03 16 01.

C.8 Motor Firmware Version (MOT_FRM)

Table 25 Motor Firmware Version

Motor firmware version (5 bytes)					
Index	byte 1	byte 2	byte 3	byte 4	byte 5
Function	MOT_FRM				

i Register Description

If byte 1=0x00, byte 2=0x22, byte 3=0x10, byte 4=0x14, byte 4=0x21, then the firmware version is: 00 22 10 14 21.

C.9 Web CGI Version (CGI_FRM)

Table 26 Web CGI Firmware Version

Web CGI firmware version (5 bytes)					
Index	byte 1	byte 2	byte 3	byte 4	byte 5
Function	CGI_FRM				

i Register Description

If byte 1=0x00, byte 2=0x23, byte 3=0x03, byte 4=0x16, byte 5=0x06, then the firmware version is: 00 22 10 14 21.

C.10 Serial Number (SN)

Table 27 Serial Number Register

Serial number register (6 bytes)						
Index	byte 1	byte 2	byte 3	byte 4	byte 5	byte 6
Function	SN					

i Register Description

Similar to a MAC address, represented in 6 bytes of hexadecimal values, indicating the product serial number.

C.11 Time Synchronization Information (TIME_SYNC_INF)

Table 28 Time Synchronization Information Register

Time synchronization information register (2 bytes)		
Index	byte 1	byte 2
Function	Time_Sync_Mode	Time_Sync_State

i Register Description

1) byte 1 represents the time synchronization mode status with the following definitions:

0x00: GPS synchronization; 0x01: E2E synchronization; 0x02: P2P synchronization; 0x03: gtp synchronization.

2) byte 2 represents the time synchronization success status with the following definitions:

0x00: Not synchronized; 0x01: Synchronization successful;

C.12 Time (UTC_TIME)

Table 29 Time Register

Time register (10 bytes)										
Index	byte 1	byte 2	byte 3	byte 4	byte 5	byte 6	byte 7	byte 8	byte 9	byte 10
Function	sec						us			

i Register Description

The value of "us" ranges from 0 to 999999. It indicates the runtime status (STATUS).

C.13 Runtime Status (STATUS)

Table 30 Runtime Status Register

Runtime status register (8 bytes)								
Index	byte 1	byte 2	byte 3	byte 4	byte 5	byte 6	byte 7	byte 8
Function	Reserved	Machine Current		Reserved			Machine Voltage	

i Register Description

- 1) Machine Current: Current of the whole machine, in Amperes. The value is composed of 2 bytes, and the calculation formula is: Machine Current = Value / 100.
- 2) Machine Voltage: Voltage of the whole machine, in Volts. The value is composed of 2 bytes, and the calculation formula is: Machine Voltage = Value / 100.

C.14 Fault Diagnosis (FALT_DIGS)

Table 31 Fault Diagnosis Register

Fault diagnosis register (24 bytes)									
Index	byte 1	byte 2	byte 3	byte 4	byte 5	byte 6	byte 7	byte 8	
Function	Start-Up Times		Reserved				GPS Status	Machine	
Index	Byte 9	byte 10	...	byte 20	byte 21	byte 22	byte 23	byte 24	
Function	Temperature	Reserved			Phase		Rotation Speed		

Table 32 GPS Signal Input Status Register

GPS 信号输入状态寄存器 GPS_ST			
Index	Function	Status Value	Status Description
bit 0	PPS Flag: PPS_LOCK	0	PPS signal invalid
		1	PPS signal valid
bit 1	GPRMC Flag: GPRMC_LOCK	0	GPRMC signal invalid
		1	GPRMC signal valid
bit 2	UTC Lock Flag: UTC_LOCK	0	UTC time not synchronized
		1	UTC time synchronized
bit 3	GPRMC Input Status	0	No input
		1	Received input
bit 4	PPS Input Status	0	No input
		1	Received input
bit 5 ~ bit 7	Reserved	x	N/A

① Register Description

- 1) Start-Up Times: Number of times the device has started, in units of times. It is composed of 2 bytes and starts refreshing after 1 minute from the power-on. Calculation formula: Start-Up Times = Value. If the two bytes overflow, i.e., the start-up times exceed 65535, it restarts counting from 0.
- 2) Machine Temperature: Product temperature, in degrees Celsius. It is composed of two bytes. Calculation formula: Machine Temperature = Value.
- 3) Phase: Real-time phase value, in degrees. It is composed of two bytes. Calculation formula: Phase = Value.
- 4) Rotation Speed: Real-time rotation speed, in RPM (Revolutions Per Minute). Calculation formula: Rotation Speed = Value.

C.15 GPRMC Data Packet - ASCII Code Data Type

The GPRMC data packet reserves 86 bytes and adapts to store the complete received GPRMC message based on the length of the GPRMC message output by the external GPS module. It allows for parsing and viewing the ASCII code.

C.16 Vertical Angle Calibration (COR_VERT_ANG)

Table 33 Vertical Angle Calibration Register

Vertical Angle Calibration Register (384 bytes)									
Index	byte 1	byte 2	byte 3	byte 4	byte 5	byte 6	byte 7	byte 8	byte 9
Function	Channel 1 Vertical Angle			Channel 2 Vertical Angle			Channel 3 Vertical Angle		
Index	byte 10	byte 11	byte 12	byte 13	byte 14	byte 15	byte 16	byte 17	byte 18
Function	Channel 4 Vertical Angle			Channel 5 Vertical Angle			Channel 6 Vertical Angle		
Index	byte 19	byte 20	byte 21	byte 22	byte 23	byte 24	byte 25	byte 26	byte 27
Function	Channel 7 Vertical Angle			Channel 8 Vertical Angle			Channel 9 Vertical Angle		
Index	byte 28	byte 29	byte 30	byte 31	byte 32	byte 33	byte 34	byte 35	byte 36
Function	Channel 10 Vertical Angle			Channel 11 Vertical Angle			Channel 12 Vertical Angle		
Index	byte 37	byte 38	byte 39	byte 40	byte 41	byte 42	byte 43	byte 44	byte 45
Function	Channel 13 Vertical Angle			Channel 14 Vertical Angle			Channel 15 Vertical Angle		
Index	byte 46	byte 47	byte 48	byte 49	byte 50	byte 51	byte 52	byte 53	byte 54
Function	Channel 16 Vertical Angle			Channel 17 Vertical Angle			Channel 18 Vertical Angle		
Index	byte 55	byte 56	byte 57	byte 58	byte 59	byte 60	byte 61	byte 62	byte 63
Function	Channel 19 Vertical Angle			Channel 20 Vertical Angle			Channel 21 Vertical Angle		
Index		
Function	...								
Index	byte 358	byte 359	byte 360	byte 361	byte 362	byte 363	byte 364	byte 365	byte 366
Function	Channel 120 Vertical Angle			Channel 121 Vertical Angle			Channel 122 Vertical Angle		
Index	byte 367	byte 368	byte 369	byte 370	byte 371	byte 372	byte 373	byte 374	byte 375
Function	Channel 123 Vertical Angle			Channel 124 Vertical Angle			Channel 125 Vertical Angle		
Index	byte 376	byte 377	byte 378	byte 379	byte 380	byte 381	byte 382	byte 383	byte 384
Function	Channel 126 Vertical Angle			Channel 127 Vertical Angle			Channel 128 Vertical Angle		

i Register Description:

- 1) The angle value is represented as positive or negative. Each channel's vertical angle is composed of 3 bytes, where the first byte indicates whether it is positive or negative, and the second and third bytes together form the angle's value.
- 2) To determine the sign (positive or negative) of the angle, check the attribute of the first byte. If the attribute of the first byte is 0x00, the channel's vertical angle is positive. If the attribute is 0x01, the channel's vertical angle is negative.

- 3) The angle resolution is 0.01° .
- 4) For example, if the value of the Channel 1 register is byte 1=0x00 (positive value), byte 2=0x00, and byte 3=0xE7 (converted to decimal 231). Then, the vertical angle value of Channel 1 is 2.31° .

C.17 Horizontal Angle Calibration (COR_HOR_ANG)

Table 34 Horizontal Angle Calibration Register

Horizontal Angle Calibration Register (384 bytes)									
Index	byte 1	byte 2	byte 3	byte 4	byte 5	byte 6	byte 7	byte 8	byte 9
Function	Channel 1 Horizontal Angle			Channel 2 Horizontal Angle			Channel 3 Horizontal Angle		
Index	byte 10	byte 11	byte 12	byte 13	byte 14	byte 15	byte 16	byte 17	byte 18
Function	Channel 4 Horizontal Angle			Channel 5 Horizontal Angle			Channel 6 Horizontal Angle		
Index	byte 19	byte 20	byte 21	byte 22	byte 23	byte 24	byte 25	byte 26	byte 27
Function	Channel 7 Horizontal Angle			Channel 8 Horizontal Angle			Channel 9 Horizontal Angle		
Index	byte 28	byte 29	byte 30	byte 31	byte 32	byte 33	byte 34	byte 35	byte 36
Function	Channel 10 Horizontal Angle			Channel 11 Horizontal Angle			Channel 12 Horizontal Angle		
Index	byte 37	byte 38	byte 39	byte 40	byte 41	byte 42	byte 43	byte 44	byte 45
Function	Channel 13 Horizontal Angle			Channel 14 Horizontal Angle			Channel 15 Horizontal Angle		
Index	byte 46	byte 47	byte 48	byte 49	byte 50	byte 51	byte 52	byte 53	byte 54
Function	Channel 16 Horizontal Angle			Channel 17 Horizontal Angle			Channel 18 Horizontal Angle		
Index	byte 55	byte 56	byte 57	byte 58	byte 59	byte 60	byte 61	byte 62	byte 63
Function	Channel 19 Horizontal Angle			Channel 20 Horizontal Angle			Channel 21 Horizontal Angle		
Index		
Function	...								
Index	byte 358	byte 359	byte 360	byte 361	byte 362	byte 363	byte 364	byte 365	byte 366
Function	Channel 120 Horizontal Angle			Channel 121 Horizontal Angle			Channel 122 Horizontal Angle		
Index	byte 367	byte 368	byte 369	byte 370	byte 371	byte 372	byte 373	byte 374	byte 375
Function	Channel 123 Horizontal Angle			Channel 124 Horizontal Angle			Channel 125 Horizontal Angle		
Index	byte 376	byte 377	byte 378	byte 379	byte 380	byte 381	byte 382	byte 383	byte 384
Function	Channel 126 Horizontal Angle			Channel 127 Horizontal Angle			Channel 128 Horizontal Angle		

Register Description:

- 1) The angle value is represented as positive or negative. Each channel's horizontal angle is composed of 3 bytes, where the first byte indicates whether it is positive or negative, and the second and third bytes together form the angle's value.
- 2) To determine the sign (positive or negative) of the angle, check the attribute of the first byte. If the attribute of the first byte is 0x00, the channel's horizontal

offset angle is positive. If the attribute is 0x01, the channel's horizontal offset angle is negative.

- 3) The angle resolution is 0.01° .
- 4) For example, if the value of Channel 1's register is byte 1=0x01 (negative angle), byte 2=0x00, and byte 3=0x04 (converted to decimal, it is 4), then Channel 1's horizontal offset angle is -0.04° .

Appendix D Accurate Point Time Calculation

In each MSOP (Multiple Sensor Overlapping Profiles) Packet, there are 3 blocks, and each block contains a complete set of 128-line laser data. The time required for 128 channels to complete one round of emission is 55.56 microseconds (us), including both emission and charging time. The laser channel ID ranges from 1 to 128.

The timestamp for each MSOP Packet corresponds to the time of the first laser point of the first channel. To calculate the time for each laser point, we need to add the time offset of each laser point to the timestamp. Please refer to Table 35 for the time offset of each laser point in a single return within an MSOP Packet.

Table 35 Time Offset of Each Laser Point in MSOP Packet

Time Offset (us)					
Channel ID	Vertical Angle	Horizontal Angle	MSOP Packet		
			BLOCK1	BLOCK2	BLOCK3
1	-11.78	5.94	0	55.56	111.112
2	-10.37	2.39	0	55.56	111.112
3	-9.27	-1.15	0	55.56	111.112
4	-8.38	-4.69	0	55.56	111.112
5	-16.07	4.70	1.217	56.773	112.329
6	-25.10	1.17	1.217	56.773	112.329
7	-19.64	-2.38	1.217	56.773	112.329
8	-13.61	-5.92	1.217	56.773	112.329
9	-6.52	5.94	2.434	57.99	113.546
10	-6.40	2.39	2.434	57.99	113.546
11	-6.31	-1.15	2.434	57.99	113.546
12	-6.21	-4.69	2.434	57.99	113.546
13	-7.67	4.72	3.652	59.208	114.764
14	-7.17	1.18	3.652	59.208	114.764
15	-6.87	-2.36	3.652	59.208	114.764
16	-6.67	-5.91	3.652	59.208	114.764
17	-5.71	5.94	4.869	60.425	115.981
18	-5.60	2.39	4.869	60.425	115.981
19	-5.51	-1.15	4.869	60.425	115.981
20	-5.41	-4.69	4.869	60.425	115.981
21	-6.10	4.72	6.086	616.642	117.198

Table 35 (Continuation)

Time Offset (us)					
Channel ID	Vertical Angle	Horizontal Angle	MSOP Packet		
			BLOCK1	BLOCK2	BLOCK3
22	-6.01	1.18	6.086	616.642	117.198
23	-5.91	-2.36	6.086	616.642	117.198
24	-5.81	-5.91	6.086	616.642	117.198
25	-4.90	5.94	7.304	62.86	118.416
26	-4.80	2.39	7.304	62.86	118.416
27	-4.70	-1.15	7.304	62.86	118.416
28	-4.60	-4.69	7.304	62.86	118.416
29	-5.30	4.72	8.521	64.077	119.633
30	-5.20	1.18	8.521	64.077	119.633
31	-5.10	-2.36	8.521	64.077	119.633
32	-5.00	-5.91	8.521	64.077	119.633
33	-4.10	5.94	9.739	65.295	120.851
34	-4.00	2.39	9.739	65.295	121.851
35	-3.90	-1.15	9.739	65.295	122.851
36	-3.80	-4.69	9.739	65.295	123.851
37	-4.50	4.72	11.323	66.879	122.435
38	-4.40	1.18	11.323	66.879	122.435
39	-4.30	-2.36	11.323	66.879	122.435
40	-4.20	-5.91	11.323	66.879	122.435
41	-3.30	5.94	12.907	68.463	124.019
42	-3.20	2.39	12.907	68.463	124.019
43	-3.10	-1.15	12.907	68.463	124.019
44	-3.00	-4.69	12.907	68.463	124.019
45	-3.70	4.72	14.924	70.48	126.036
46	-3.60	1.18	14.924	70.48	126.036
47	-3.50	-2.36	14.924	70.48	126.036
48	-3.40	-5.90	14.924	70.48	126.036
49	-2.50	5.94	16.941	72.497	128.053
50	-2.39	2.39	16.941	72.497	128.053
51	-2.30	-1.15	16.941	72.497	128.053
52	-2.20	-4.69	16.941	72.497	128.053
53	-2.90	4.72	18.959	74.515	130.071
54	-2.80	1.18	18.959	74.515	130.071
55	-2.70	-2.36	18.959	74.515	130.071
56	-2.60	-5.90	18.959	74.515	130.071
57	-1.69	5.94	20.976	76.532	132.088
58	-1.59	2.39	20.976	76.532	132.088

Table 35 (Continuation)

Time Offset (us)					
Channel ID	Vertical Angle	Horizontal Angle	MSOP Packet		
			BLOCK1	BLOCK2	BLOCK3
59	-1.49	-1.15	20.976	76.532	132.088
60	-1.39	-4.69	20.976	76.532	132.088
61	-2.09	4.72	23.127	78.683	134.239
62	-2.00	1.18	23.127	78.683	134.239
63	-1.90	-2.36	23.127	78.683	134.239
64	-1.80	-5.90	23.127	78.683	134.239
65	-0.89	5.94	25.278	80.834	136.390
66	-0.79	2.39	25.278	80.834	136.390
67	-0.69	-1.15	25.278	80.834	136.390
68	-0.59	-4.69	25.278	80.834	136.390
69	-1.29	4.72	27.428	82.984	138.54
70	-1.19	1.18	27.428	82.984	138.54
71	-1.09	-2.36	27.428	82.984	138.54
72	-0.99	-5.90	27.428	82.984	138.54
73	-0.09	5.94	29.579	85.135	140.691
74	0.01	2.39	29.579	85.135	140.691
75	0.11	-1.15	29.579	85.135	140.691
76	0.21	-4.69	29.579	85.135	140.691
77	-0.49	4.72	31.963	87.519	143.075
78	-0.39	1.18	31.963	87.519	143.075
79	-0.29	-2.36	31.963	87.519	143.075
80	-0.19	-5.90	31.963	87.519	143.075
81	0.71	5.94	34.347	89.903	145.459
82	0.81	2.39	34.347	89.903	145.459
83	0.91	-1.15	34.347	89.903	145.459
84	1.01	-4.69	34.347	89.903	145.459
85	0.31	4.72	36.498	92.054	147.61
86	0.41	1.18	36.498	92.054	147.61
87	0.51	-2.36	36.498	92.054	147.61
88	0.61	-5.90	36.498	92.054	147.61
89	1.51	5.94	38.648	94.204	149.76
90	1.61	2.39	38.648	94.204	149.76
91	1.71	-1.15	38.648	94.204	149.76
92	1.82	-4.69	38.648	94.204	149.76
93	1.11	4.72	40.666	96.222	151.778
94	1.21	1.18	40.666	96.222	151.778
95	1.31	-2.36	40.666	96.222	151.778

Table 35 (Continuation)

Time Offset (us)					
Channel ID	Vertical Angle	Horizontal Angle	MSOP Packet		
			BLOCK1	BLOCK2	BLOCK3
96	1.41	-5.90	40.666	96.222	151.778
97	2.32	5.94	42.683	98.239	153.795
98	2.41	2.39	42.683	98.239	153.795
99	2.52	-1.15	42.683	98.239	153.795
100	2.62	-4.69	42.683	98.239	153.795
101	1.91	4.72	44.267	99.823	155.379
102	2.02	1.18	44.267	99.823	155.379
103	2.12	-2.36	44.267	99.823	155.379
104	2.22	-5.90	44.267	99.823	155.379
105	3.12	5.94	45.851	101.407	156.963
106	3.22	2.39	45.851	101.407	156.963
107	3.32	-1.15	45.851	101.407	156.963
108	3.42	-4.69	45.851	101.407	156.963
109	2.72	4.72	47.435	102.991	158.547
110	2.82	1.18	47.435	102.991	158.547
111	2.92	-2.36	47.435	102.991	158.547
112	3.02	-5.90	47.435	102.991	158.547
113	3.97	5.94	49.019	104.575	160.131
114	4.17	2.39	49.019	104.575	160.131
115	4.42	-1.15	49.019	104.575	160.131
116	4.72	-4.69	49.019	104.575	160.131
117	3.52	4.72	50.603	106.159	161.715
118	3.62	1.18	50.603	106.159	161.715
119	3.72	-2.36	50.603	106.159	161.715
120	3.82	-5.91	50.603	106.159	161.715
121	7.43	5.94	52.187	107.743	163.299
122	9.02	2.39	52.187	107.743	163.299
123	11.53	-1.15	52.187	107.743	163.299
124	15.04	-4.70	52.187	107.743	163.299
125	5.07	4.72	53.771	109.327	164.883
126	5.48	1.18	53.771	109.327	164.883
127	5.98	-2.36	53.771	109.327	164.883
128	6.58	-5.91	53.771	109.327	164.883

i Note:

In dual return mode, the Data Block's odd-numbered column contains 128 channels storing the data from the first return, and the even-numbered column contains 128 channels storing the data from the second return.

Appendix E Channel Ranging Capability Table

Table 36 Channel Ranging Capability

Channel Number	Vertical Angle (°)	Blind Zone (m)	Ranging @ 10% Target Reflectivity (m)	Maximum Ranging Distance (m)	Channel Number	Vertical Angle (°)	Blind Zone (m)	Ranging @ 10% Target Reflectivity (m)	Maximum Ranging Distance (m)
1	-11.78	0.4	70	70	65	-0.89	1	240	250
2	-10.37	3	70	70	66	-0.79	3	240	250
3	-9.27	1	70	70	67	-0.69	1	240	250
4	-8.38	1	70	70	68	-0.59	3	240	250
5	-16.07	0.4	70	70	69	-1.29	1	240	250
6	-25.1	0.4	70	70	70	-1.19	3	240	250
7	-19.64	0.4	70	70	71	-1.09	1	240	250
8	-13.61	0.4	70	70	72	-0.99	3	240	250
9	-6.52	0.4	70	70	73	-0.09	1	240	250
10	-6.4	3	70	70	74	0.01	3	240	250
11	-6.31	0.4	70	70	75	0.11	1	240	250
12	-6.21	3	70	70	76	0.21	3	240	250
13	-7.67	0.4	70	70	77	-0.49	1	240	250
14	-7.17	3	70	70	78	-0.39	3	240	250
15	-6.87	0.4	70	70	79	-0.29	1	240	250
16	-6.67	1	70	70	80	-0.19	3	240	250
17	-5.71	1	70	70	81	0.71	1	240	250
18	-5.6	3	70	70	82	0.81	3	240	250
19	-5.51	0.4	70	70	83	0.91	0.4	240	250
20	-5.41	3	70	70	84	1.01	3	240	250
21	-6.1	1	70	70	85	0.31	1	240	250
22	-6.01	3	70	70	86	0.41	3	240	250
23	-5.91	0.4	70	70	87	0.51	1	240	250
24	-5.81	3	70	70	88	0.61	3	240	250
25	-4.9	1	70	70	89	1.51	1	135	180
26	-4.8	3	70	70	90	1.61	3	135	180
27	-4.7	0.4	70	70	91	1.71	1	135	180
28	-4.6	3	70	70	92	1.82	3	135	180
29	-5.3	1	70	70	93	1.11	1	135	180
30	-5.2	3	70	70	94	1.21	3	135	180
31	-5.1	1	70	70	95	1.31	0.4	135	180
32	-5	3	70	70	96	1.41	3	135	180
33	-4.1	1	120	120	97	2.32	1	120	120
34	-4	3	120	120	98	2.41	3	120	120

Table 36 (Continuation)

Channel Number	Vertical Angle (°)	Blind Zone (m)	Ranging @ 10% Target Reflectivity (m)	Maximum Ranging Distance (m)	Channel Number	Vertical Angle (°)	Blind Zone (m)	Ranging @ 10% Target Reflectivity (m)	Maximum Ranging Distance (m)
35	-3.9	0.4	120	120	99	2.52	1	120	120
36	-3.8	3	120	120	100	2.62	3	120	120
37	-4.5	1	120	120	101	1.91	1	120	120
38	-4.4	3	120	120	102	2.02	3	120	120
39	-4.3	0.4	120	120	103	2.12	1	120	120
40	-4.2	3	120	120	104	2.22	3	120	120
41	-3.3	1	135	180	105	3.12	1	120	120
42	-3.2	3	135	180	106	3.22	3	120	120
43	-3.1	0.4	135	180	107	3.32	1	120	120
44	-3	3	135	180	108	3.42	3	120	120
45	-3.7	1	135	180	109	2.72	1	120	120
46	-3.6	3	135	180	110	2.82	3	120	120
47	-3.5	0.4	135	180	111	2.92	0.4	120	120
48	-3.4	3	135	180	112	3.02	3	120	120
49	-2.5	1	180	180	113	3.97	0.4	120	120
50	-2.39	3	180	180	114	4.17	3	120	120
51	-2.3	0.4	180	180	115	4.42	1	120	120
52	-2.2	3	180	180	116	4.72	3	120	120
53	-2.9	1	180	180	117	3.52	1	120	120
54	-2.8	3	180	180	118	3.62	3	120	120
55	-2.7	1	180	180	119	3.72	0.4	120	120
56	-2.6	3	180	180	120	3.82	3	120	120
57	-1.69	1	240	250	121	7.43	1	120	120
58	-1.59	3	240	250	122	9.02	3	120	120
59	-1.49	0.4	240	250	123	11.53	0.4	120	120
60	-1.39	3	240	250	124	15.04	0.4	120	120
61	-2.09	1	240	250	125	5.07	0.4	120	120
62	-2	3	240	250	126	5.48	3	120	120
63	-1.9	1	240	250	127	5.98	0.4	120	120
64	-1.8	3	240	250	128	6.58	1	120	120

Appendix F Mechanical Drawings

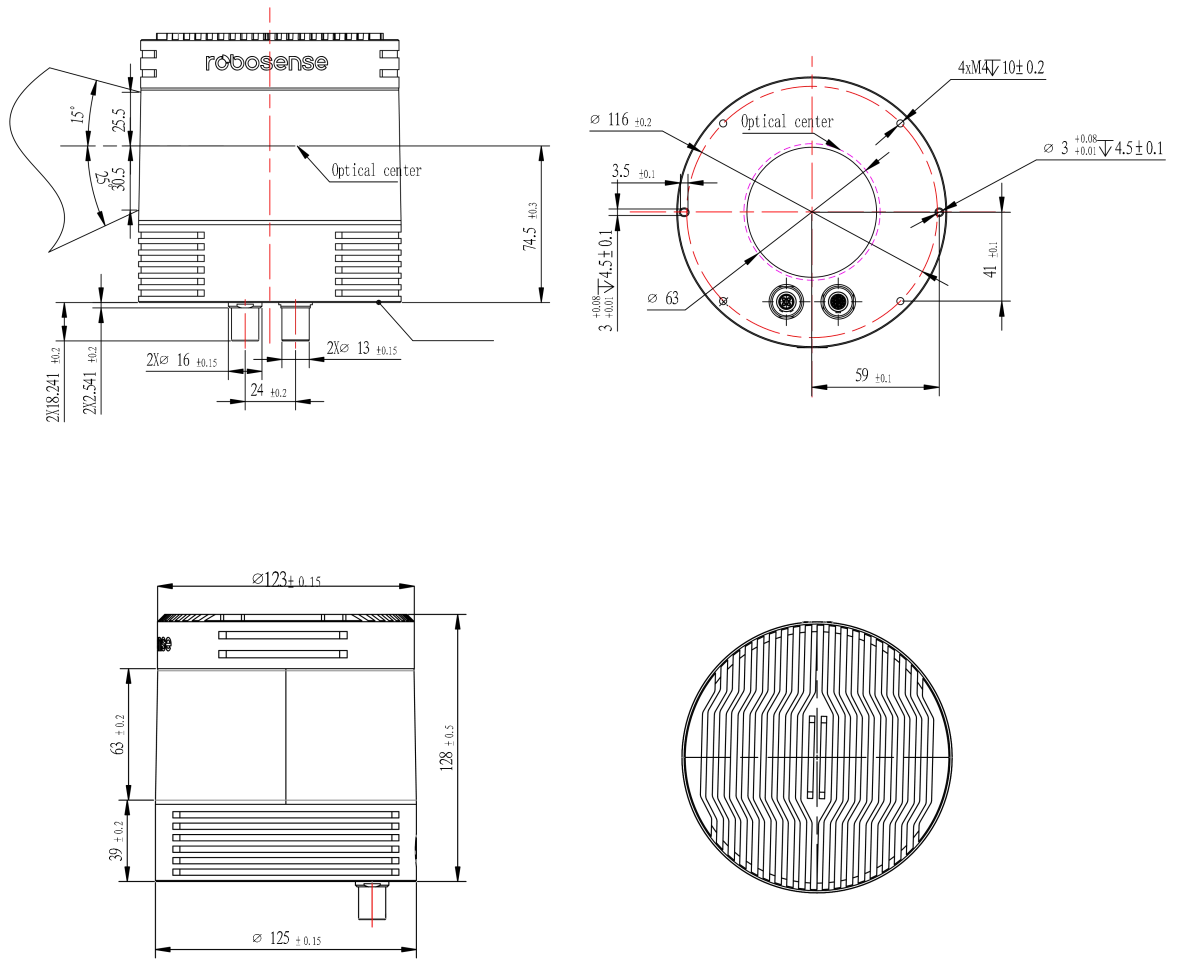



Building 9, Block 2, Zhongguan Honghualing Industry Southern District, 1213
Liuxian Avenue, Taoyuan Street, Nanshan District, Shenzhen, China
www.robosense.ai